



For Android™ 9

# Enterprise Mobility

# PM90

# User Manual

# User Manual

Please note your phone is battery-embedded design with removable battery and battery cover. Unauthorized personnel are strictly prohibited from disassembling the phone. Make sure to use only the power adapter (5V 2A Output AC/DC) that came with PM90.

In case your phone does not work as expected, you are strongly recommended to restart it by pressing and holding the power button for at least 12 seconds until the startup screen appears. If your phone has encountered a serious error and cannot be recovered, you should reset your phone to factory settings by using the menu, either “Backup & Reset”, or “Factory Reset”. For more details, please refer to “[Factory data reset](#)” section.

**Note:** Please be cautious while performing the factory data reset. Because this will erase personalized settings and data saved in your phone, such as SMS, Contacts, Music, etc.

**Screenshots in this manual may different compare with latest Android App version**

Rev 05

# Table of Contents

<b>User Manual .....</b>	<b>1</b>
<b>Table of Contents .....</b>	<b>2</b>
<b>Getting Started.....</b>	<b>4</b>
Major Parts .....	4
Setup PM90.....	7
Turn On/Off PM90.....	9
Hot swap the Battery .....	10
Charge PM90.....	12
<b>Learning the basics.....</b>	<b>14</b>
Use a keypad .....	14
Use a touch screen .....	16
Setup Wizard.....	18
Home Screen, Apps and Widget.....	24
Status & Notifications Icons .....	33
Set a Lock screen.....	35
Manage a display .....	37
Make a call .....	40
Add to a contact.....	42
Connect to your Wi-Fi network.....	44
Make a Wi-Fi hotspot.....	46
Connect with Bluetooth device .....	47
Use a Camera.....	49
Manage files and folders .....	51
MTP connection with PC.....	58
<b>Scanner Settings .....</b>	<b>61</b>
Use a Scanner .....	61
Scan a Barcode .....	68
<b>OS Update .....</b>	<b>70</b>
OS Image update from a Storage.....	70

OS Image update from the FOTA..... 73

**Factory data reset ..... 75**

    Factory data reset from Settings..... 75

    Force Factory data reset ..... 78

**Safety and Legal Info ..... 80**

# Major Parts

## Getting Started

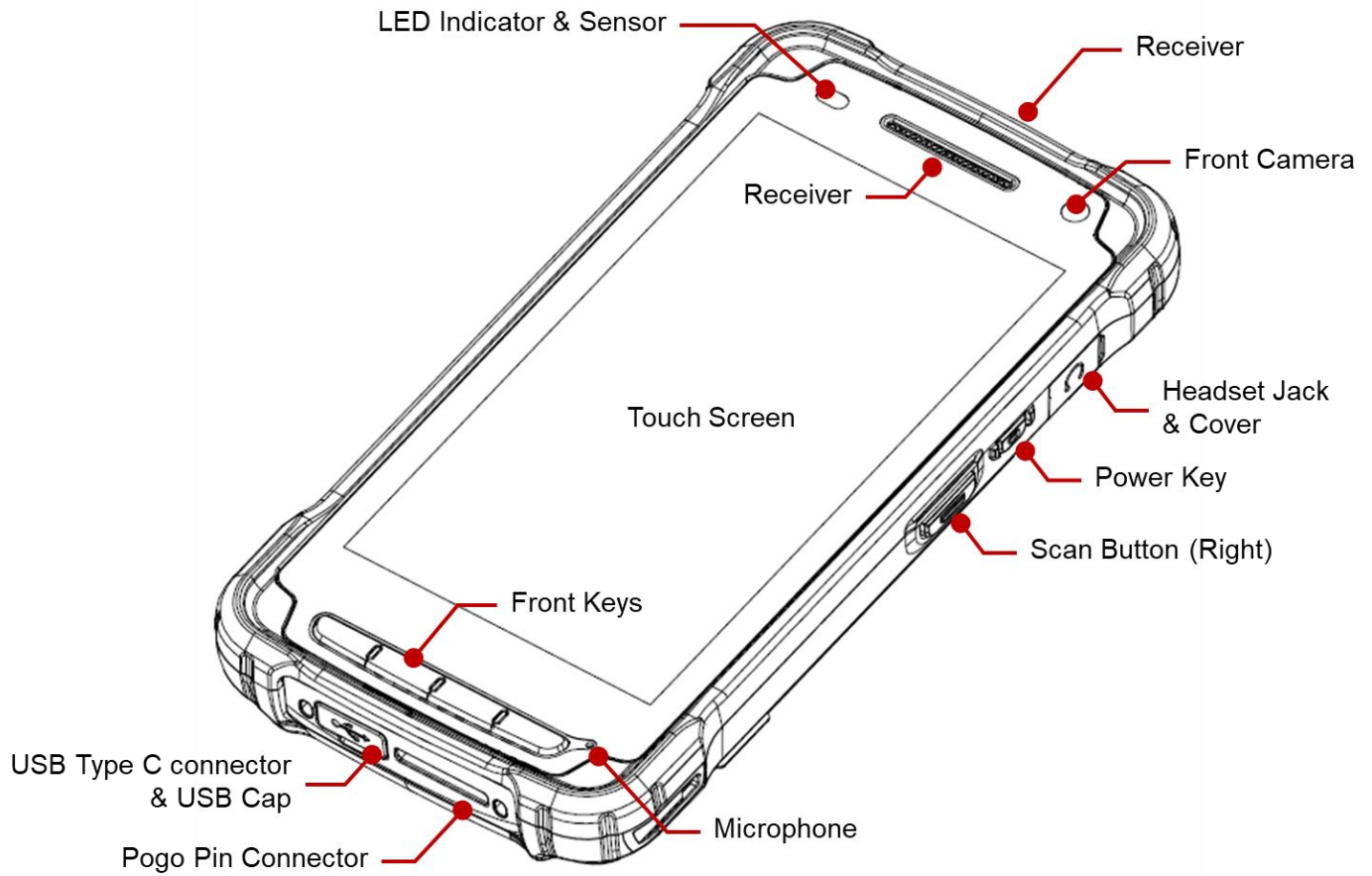

# Major Parts

## Getting Started

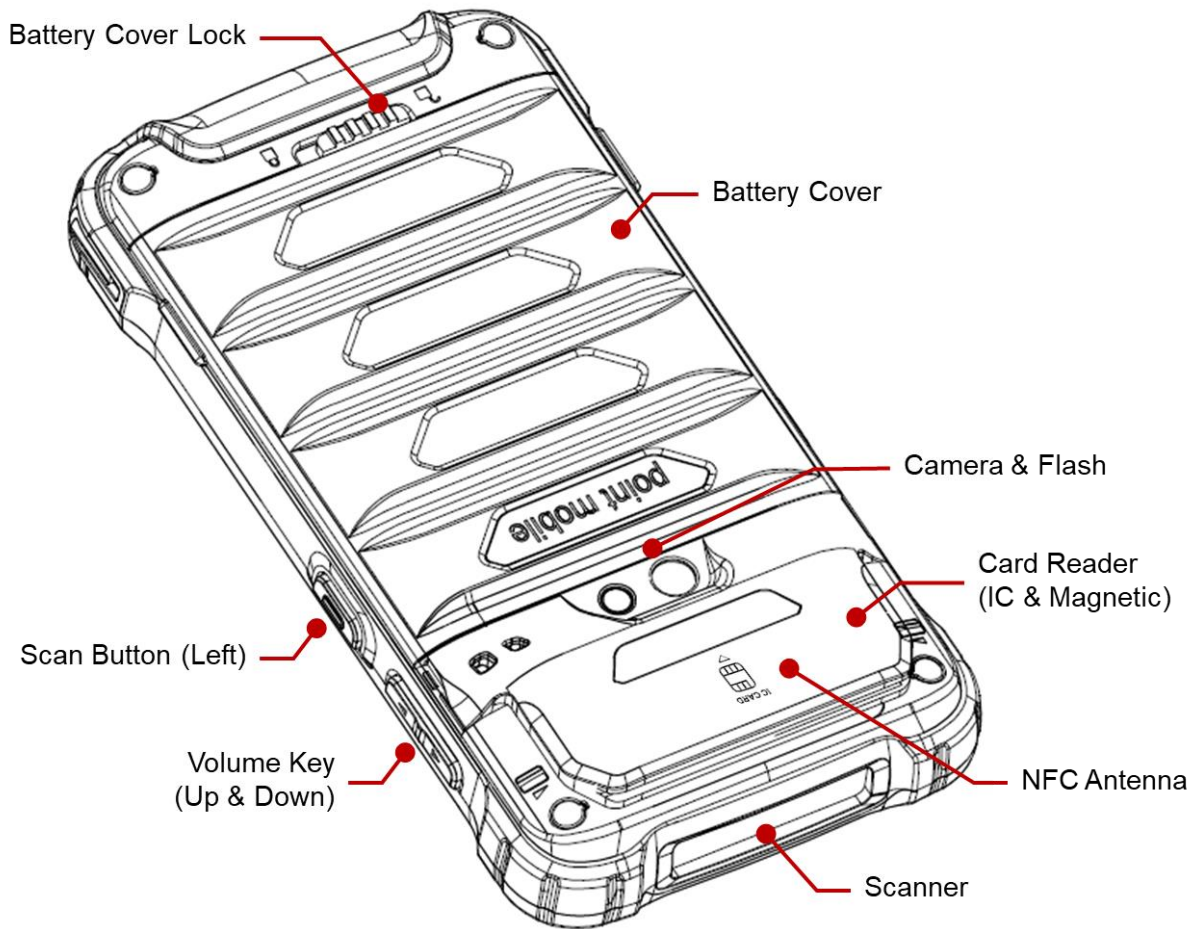

# Major Parts

## Getting Started

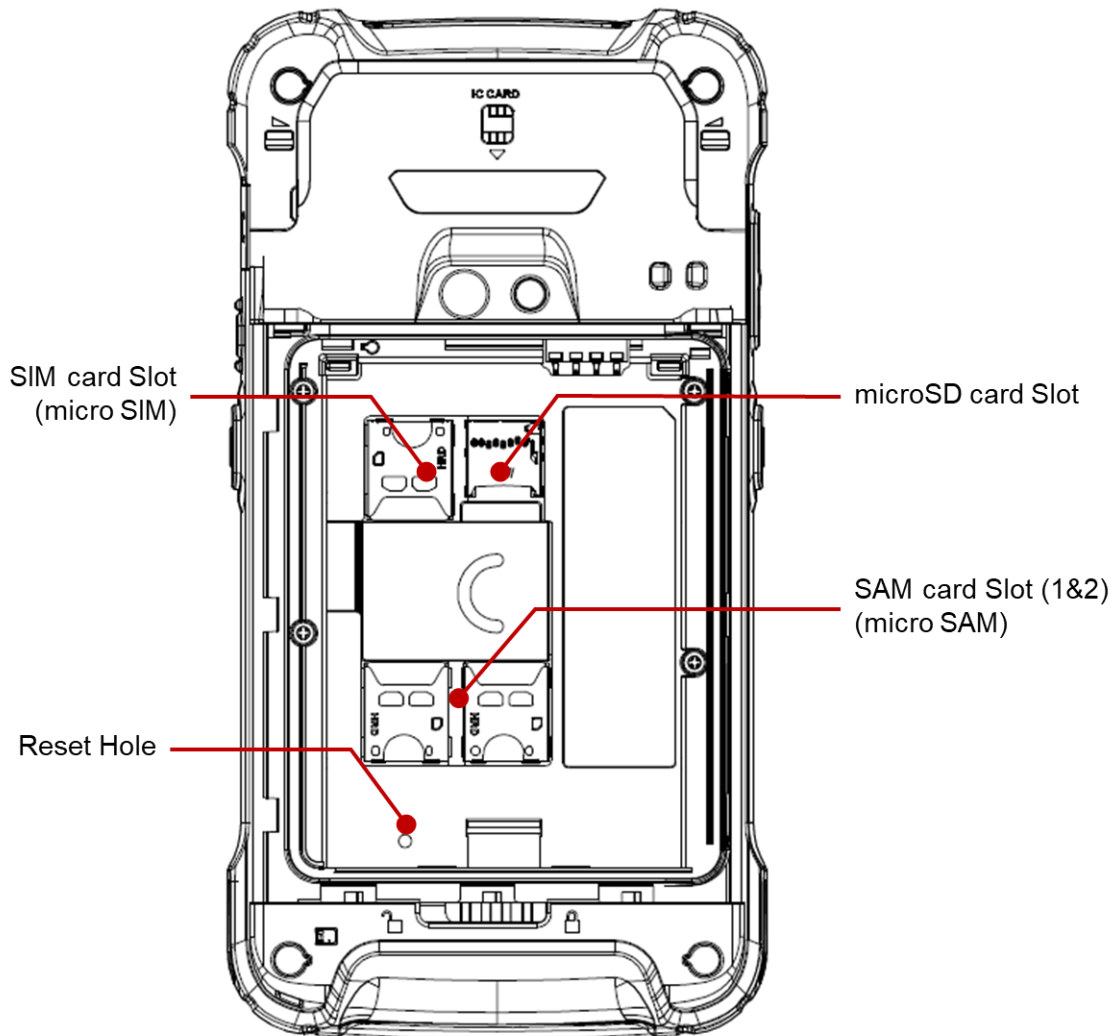

**Note 1:** PM90 only supports the micro SIM cards. Do not insert a size modified card with SIM adapter. Size modified card is thicker than the standard Nano SIM card and may damage the card slot



**Note 2:** PM90 supports up to 32GB microSD card

# Setup PM90

## Getting Started

### Remove the Battery Cover

1. Slide **Battery Cover Lock** to the **Unlock**  position
2. Pull up the **Battery Cover** from bottom side area

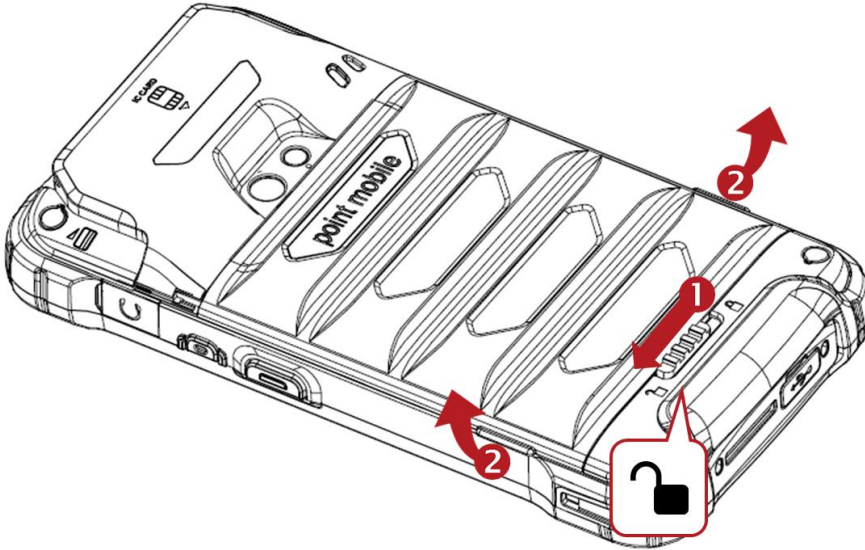

### Install micro SIM card, micro SAM card and microSD card

1. Insert the micro SIM card, micro SAM card and microSD card into each slot (Gold contact should face down)

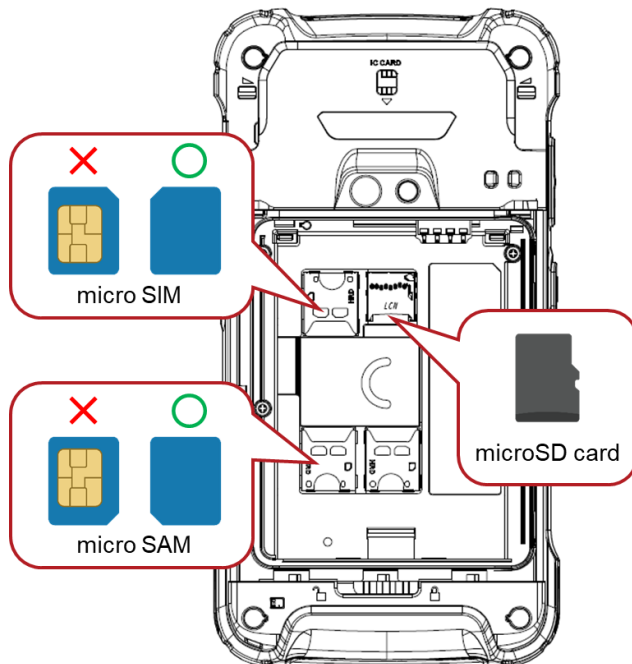

2. To remove the card, gently slide it out of the slot.





# Setup PM90

## Getting Started

### Insert the Battery

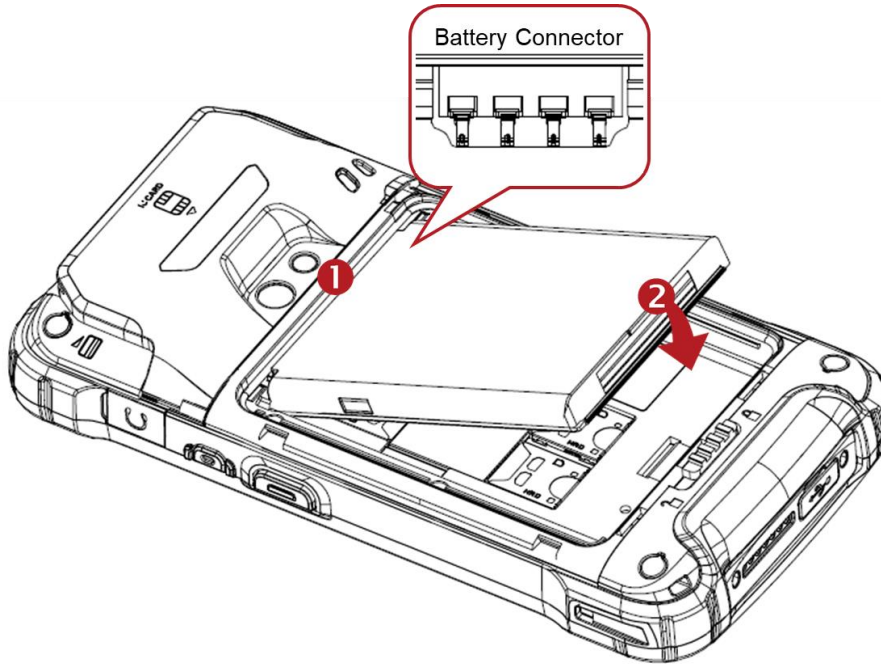
1. Insert Battery from the top first, and then put in the bottom. Make sure battery contact **Battery Connector**



2. Insert the Battery Cover from the top area first and then put in bottom area. Press Battery Cover with both hand and Make sure **Battery Cover Lock** is **Lock**  position

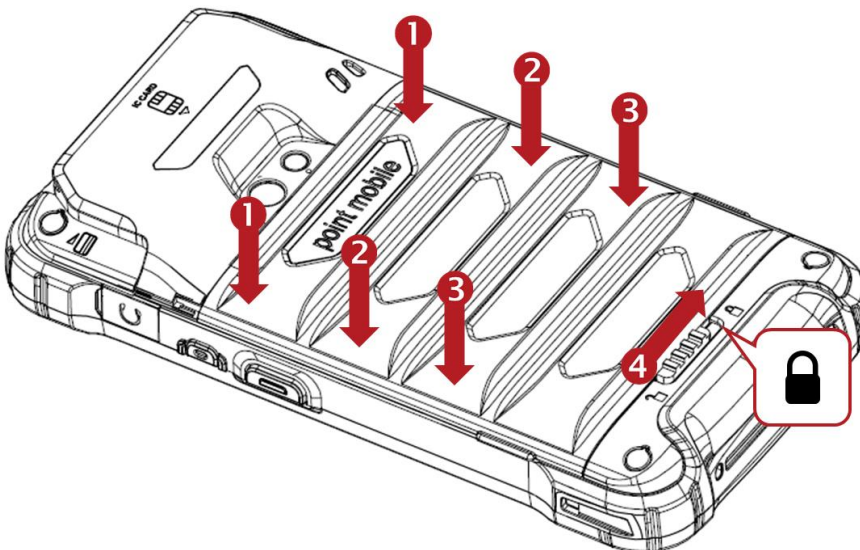

# Turn On/Off PM90

## Getting Started

### Turn On

1. Press and hold the **Power Key** for a few seconds
2. When PM90 enter to the boot mode, it will display “SMART BEYOND RUGGED” logo
3. Release the Power Key and wait until PM90 finish booting

**Note:** If you cannot turn on your PM90, please try below steps

- To turn on PM90, battery needs to be charged certain level. Please charge first
- Press and hold the “Power key” for over 12 seconds to force reboot
- Press and release the Reset Hole and then turn on PM90 again

### Turn Off

1. Press and hold the “Power Key” until you see the power menu

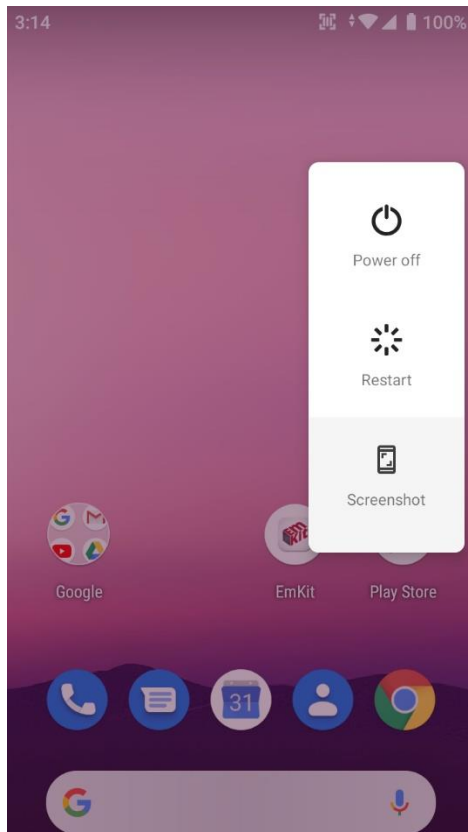

2. Touch **Power Off**

# Hot swap the Battery

## Getting Started

When Battery level is low, you can replace the battery without turning off and on the PM90

1. Remove Battery Cover

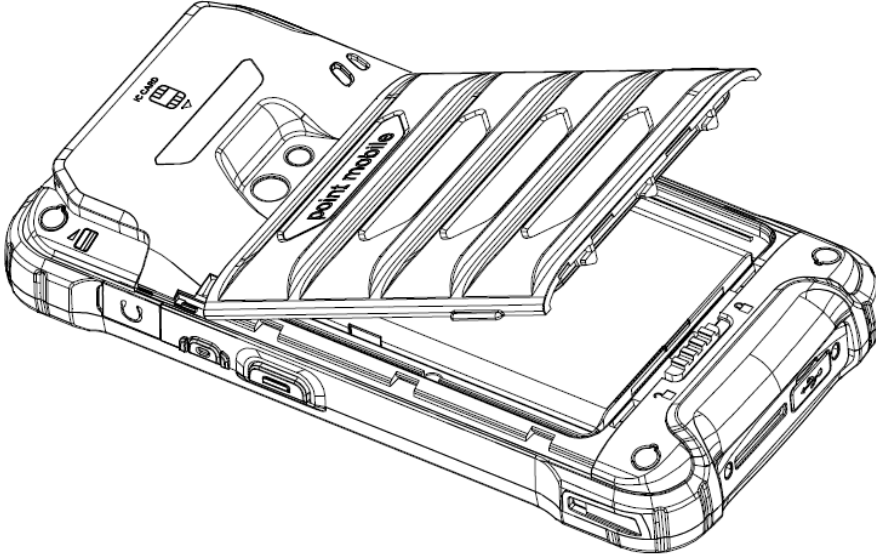

2. Replace the Battery

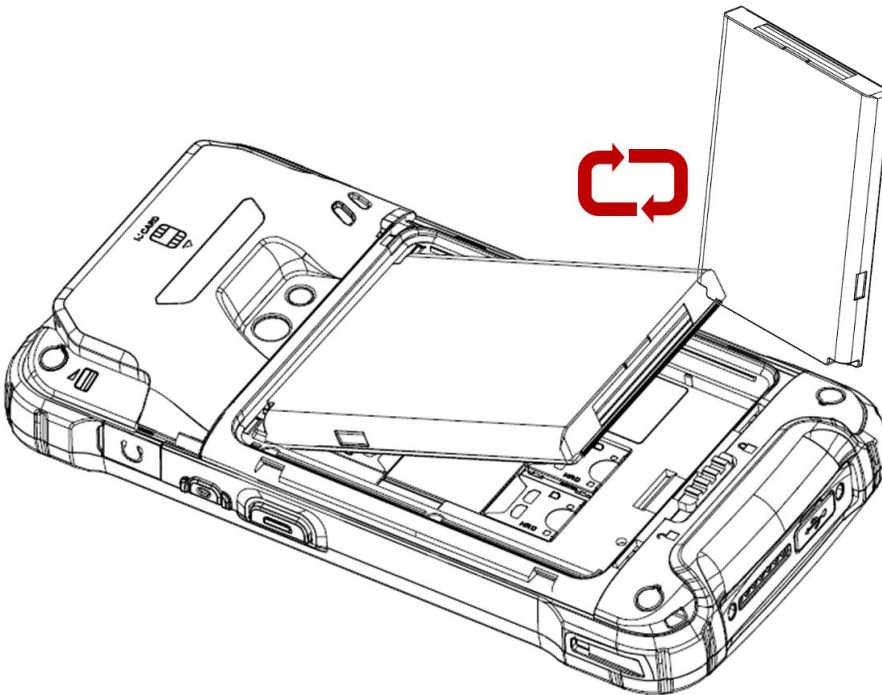

## Hot swap the Battery

### Getting Started

3. Close the Battery Cover firmly. Make sure **Battery Cover Lock** is **Lock**  position

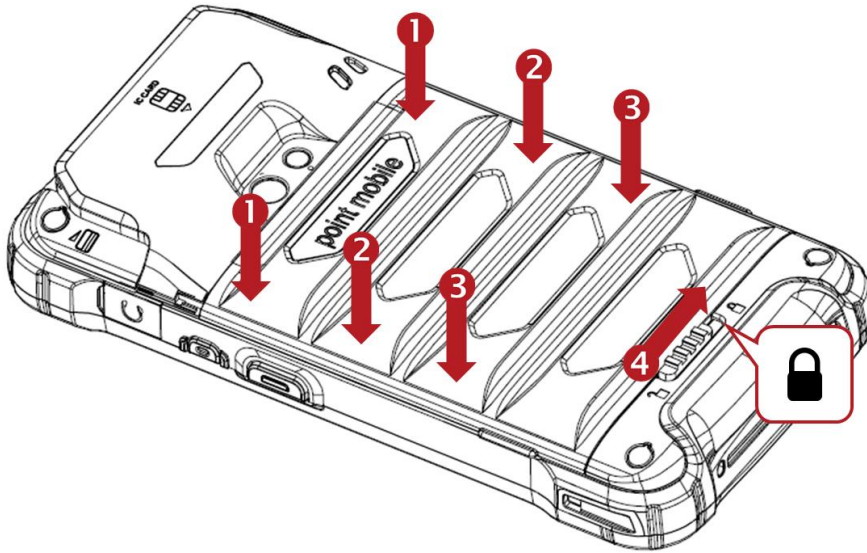

## Charge PM90

### Getting Started

1. Assemble the country code and AC adapter first. Connect USB cable to assembled AC adapter
2. Connect another side, USB type C connector to the PM90 and apply the power from wall socket

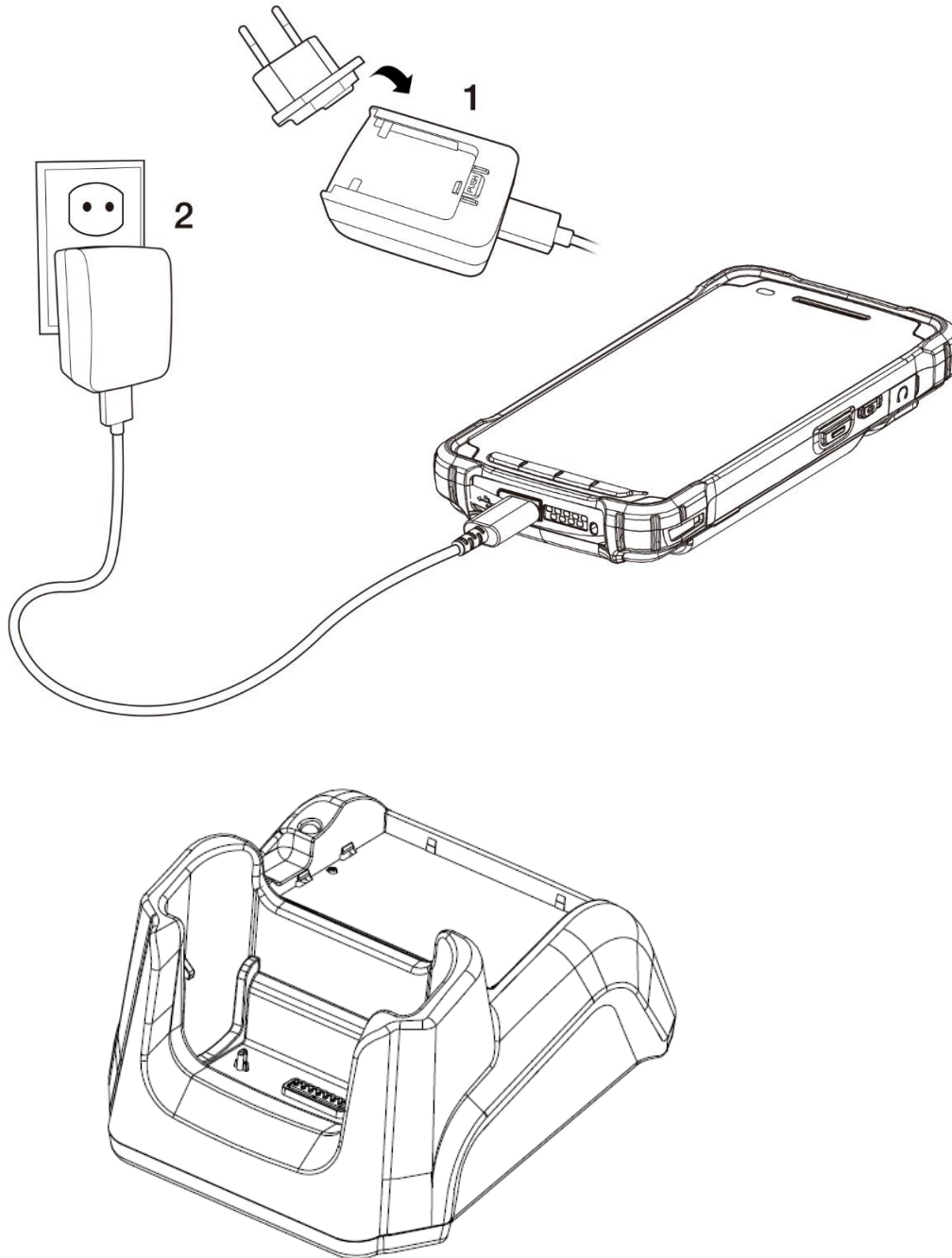

You can also charge the PM90 with cradle (optional accessory)

## Charge PM90

## Getting Started

3. LED indicator will display charging status

Steady Red	Battery is charging or Battery level is low
Blinking Red	Battery level is critical low
Steady Green	Battery is fully charged

### Battery specification

Standard Battery	2,900mAh 3.85V
Extended Battery	5,800mAh 3.85V
Backup Battery	60mAh 3.7V
Charging time	Standard Battery : About 4 hours Extend Battery : About 6 hours

**Note:** Always use an original charger and cable from the Point Mobile. Other chargers and cables may damage PM90.

In addition, make sure connector, charger, cables are not wet

# Use a keypad

## Learning the basics

### Power key



Press

- Lock the screen / Light up the screen.

Press and hold

- Display the power menu “Power Off / Restart / Screenshot”

Press and hold over 12 seconds

- Force rebooting

Press and hold the **Power key** and **Volume Down key** together

- Screen capture

### Volume keys



In general

- Adjusts the media and ringtone volume
- **Mute** the ringtone during an incoming call (Volume Up / Down key)

In voice call

- Adjusts the volume (Speaker or Headphone)

In camera preview

- Take a photo (Volume Up / Down key)

### Scan Button



When **Scan Wedge** mode is activated

- By pressing, PM90 scan the barcode

---

## Use a keypad

Learning the basics

### Front Keys

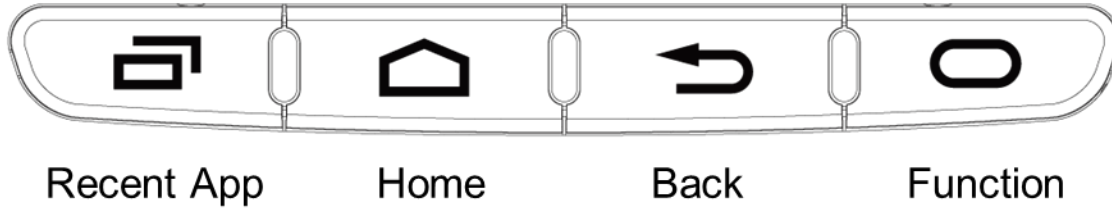

- Recent App**      Press to see recently used apps
- Home**              From any apps or screens, press to return to the Home screen
- Back**                Press to go back to the previous screen, or to close a dialog box, options menu, notification panel, etc
- Function**            Press to run the function or run the preset action. You can set **EmKit - Program Buttons**



---

## Use a touch screen

### Learning the basics

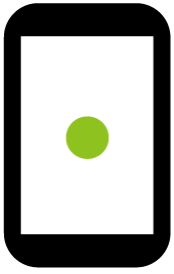

#### Touch

One-finger press

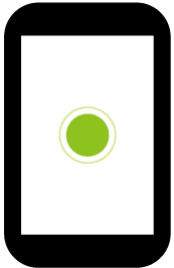

#### Double touch

One-finger press, lift, one-finger press, lift for **Zoom in**



#### Long press

One-finger press, wait, lift for **Select an item**

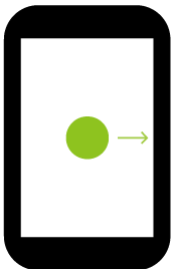

#### Drag, Swipe, or Fling

One-finger press, move, lift for **Scroll** or **Tilt**

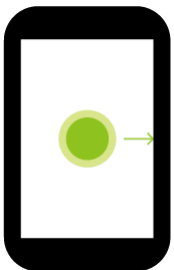

#### Long-press drag

One-finger press, wait, move, lift for **Pick up and move** or **Select multiple items**

---

## Use a touch screen

### Learning the basics

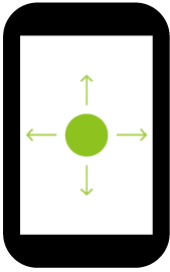

#### Scroll

Vertical or horizontal **Swipe** in a single direction

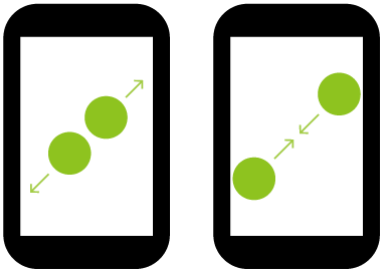

#### Pinch Open & Close

Two-finger press, move outwards and in words, lift for **Zoom in and out**



#### Rotate

When PM90 is turning sideways, screen orientation is changing

# Setup Wizard

## Learning the basics

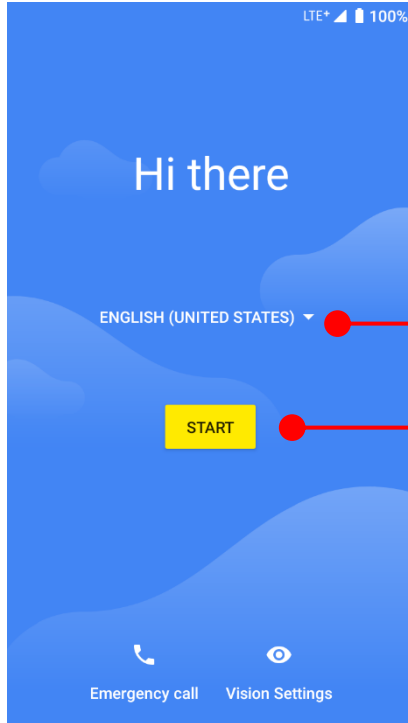

When you power on your device very first time or boot after factory reset, you need to setup your device first

### Language Selection

- Choose your language during setup process.

Touch to start setup your device

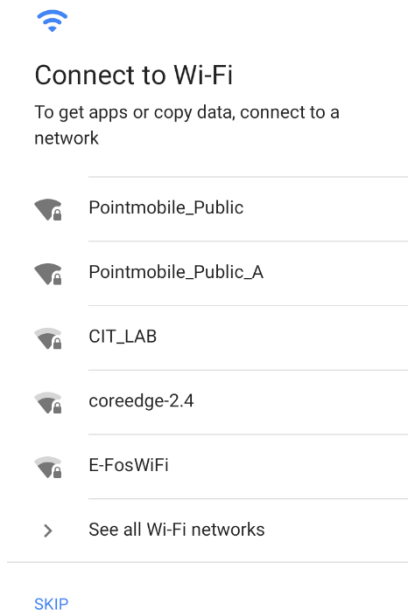

To setup your device, Android requires internet connection. Please connect to your Wi-Fi network or use mobile network in this step

 Icon means: Open Wi-Fi network. You don't need to enter the password

 Icon means: Secured Wi-Fi network. To connect this Wi-Fi, you need to enter the password

# Setup Wizard

## Learning the basics

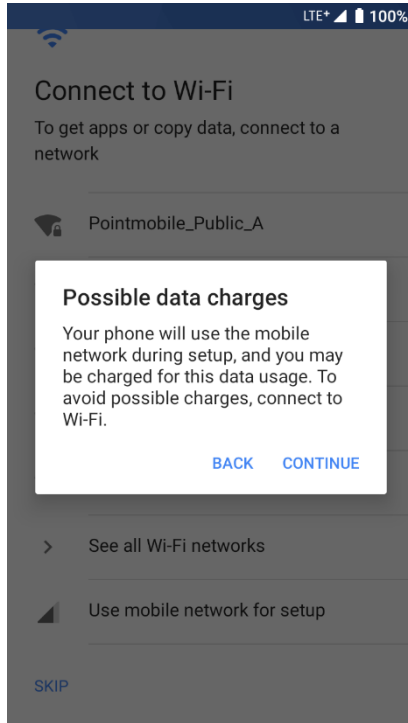

**Note:** If you choose **Use mobile network for setup** option, you may be charged for mobile data usage.

# Setup Wizard

## Learning the basics

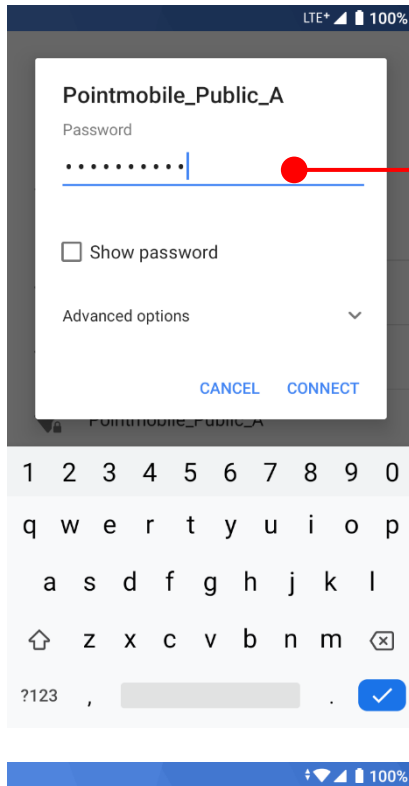

Please select Wi-Fi network and input the password (If required)



Checking for updates...

Installing updates



Android will check updates in Setup process and move to next step

# Setup Wizard

## Learning the basics



### Copy apps & data

Transfer your apps, photos, contacts, Google Account, and more. You can choose which content to copy.

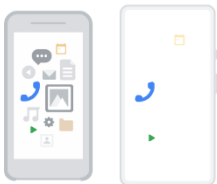

DON'T COPY

NEXT

After internet connection, Android will ask set PM90 as new device or copy apps & data from Google account

#### Next

- You can copy your settings from other Android phone or Google account or iPhone

#### Don't Copy

- Set your PM90 as your new device



### Bring your data from...



A backup from an Android phone  
Use your old phone to copy data wirelessly



A backup from the cloud  
Sign in with your username & password



An iPhone® device

#### Next option

- PM90 will sync the setting from other Android phone or Google account or iPhone

DON'T COPY



Touch to go back previous step

# Setup Wizard

## Learning the basics

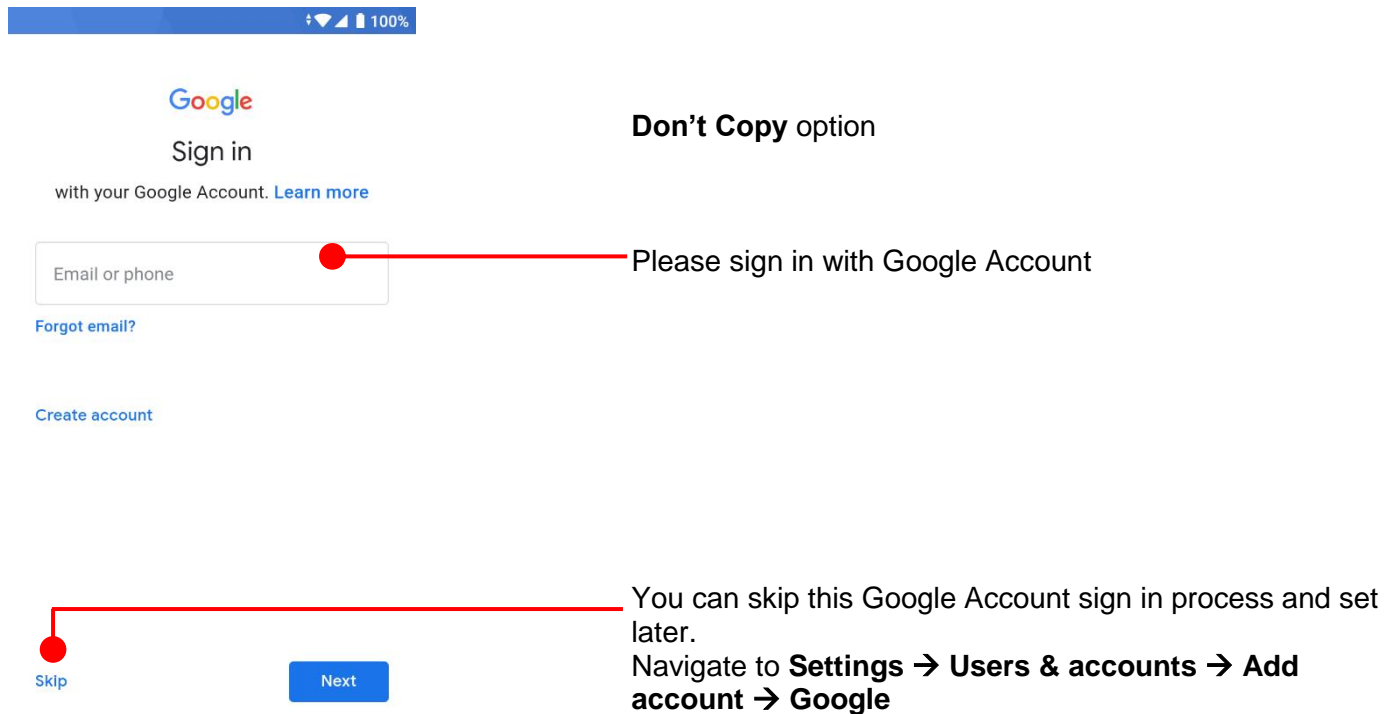

Google

Sign in

with your Google Account. [Learn more](#)

Email or phone

[Forgot email?](#)

[Create account](#)

[Skip](#) [Next](#)

**Don't Copy** option

Please sign in with Google Account

You can skip this Google Account sign in process and set later.  
Navigate to **Settings** → **Users & accounts** → **Add account** → **Google**

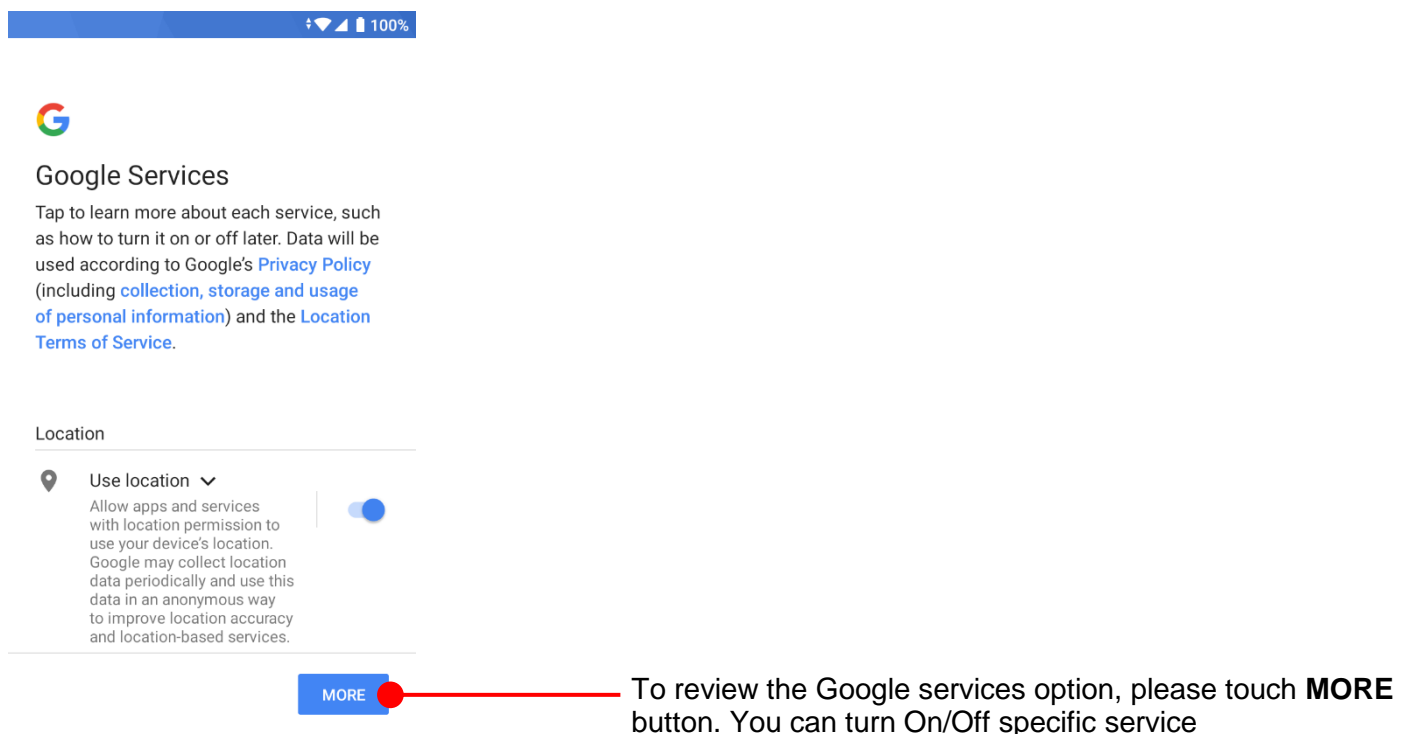

Google

Google Services

Tap to learn more about each service, such as how to turn it on or off later. Data will be used according to Google's [Privacy Policy](#) (including [collection, storage and usage of personal information](#)) and the [Location Terms of Service](#).

Location

Use location  [MORE](#)

Allow apps and services with location permission to use your device's location. Google may collect location data periodically and use this data in an anonymous way to improve location accuracy and location-based services.

To review the Google services option, please touch **MORE** button. You can turn On/Off specific service

# Setup Wizard

## Learning the basics

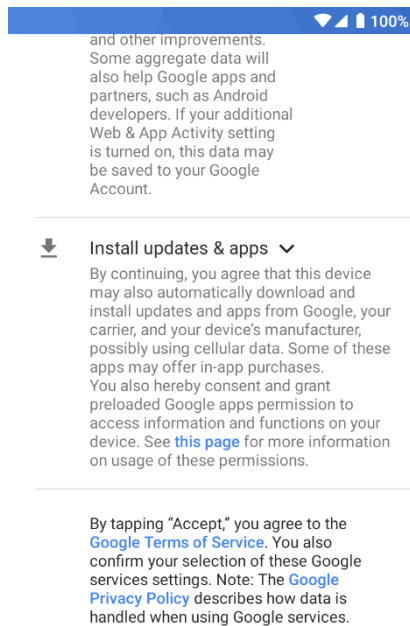

and other improvements. Some aggregate data will also help Google apps and partners, such as Android developers. If your additional Web & App Activity setting is turned on, this data may be saved to your Google Account.

**Install updates & apps** ▾

By continuing, you agree that this device may also automatically download and install updates and apps from Google, your carrier, and your device's manufacturer, possibly using cellular data. Some of these apps may offer in-app purchases. You also hereby consent and grant preloaded Google apps permission to access information and functions on your device. See [this page](#) for more information on usage of these permissions.

By tapping "Accept," you agree to the [Google Terms of Service](#). You also confirm your selection of these Google services settings. Note: The [Google Privacy Policy](#) describes how data is handled when using Google services.

**ACCEPT**

After your reviewing and set Google services option, touch **ACCEPT** button for next step

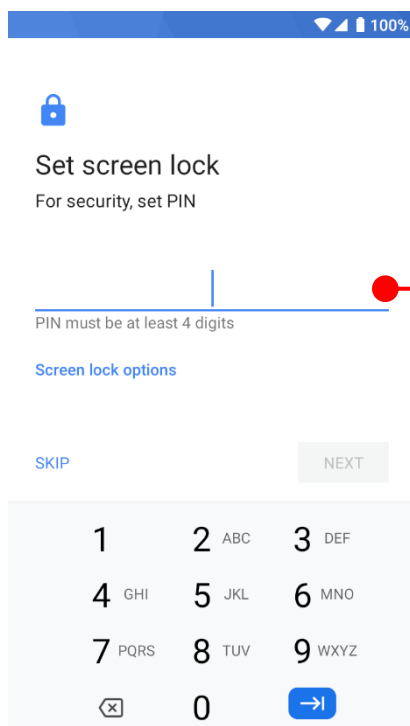

**Set screen lock**

For security, set PIN

PIN must be at least 4 digits

[Screen lock options](#)

SKIP **NEXT**

1 2 ABC 3 DEF  
4 GHI 5 JKL 6 MNO  
7 PQRS 8 TUV 9 WXYZ  
⏪ 0 →

Choose security option for lock screen. You set specific pattern or PIN or password here. You may skip this process and set later. Navigate to **Settings → Security & location → Screen lock**



# Home Screen, Apps and Widget

## Learning the basics

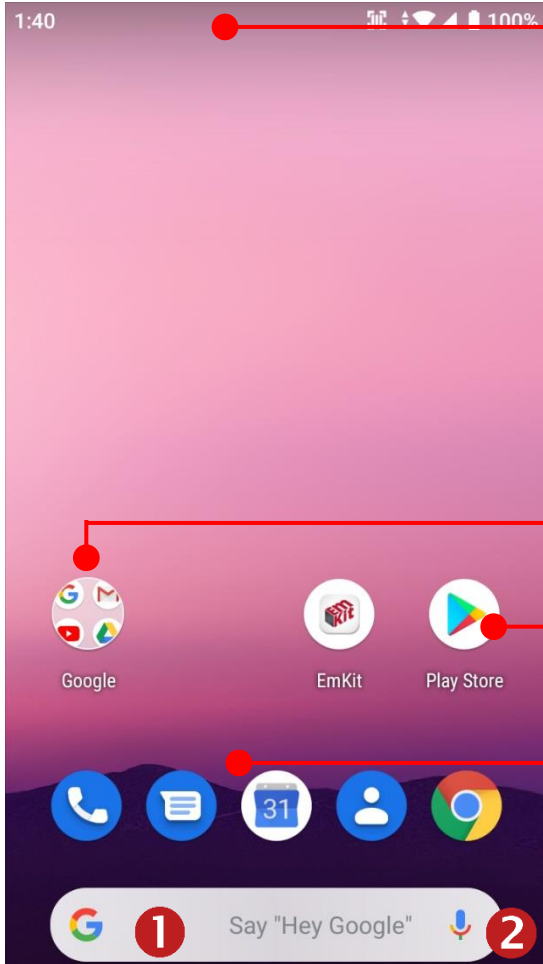

### Status Bar

- Status / Notification
- Drag down to open the Quick settings panel

### App Folder (Google collections)

- App icons are organized in the folder

Touch an icon to run an app, open a folder, etc

### Favorite tray apps

- Touch to run an app
- Touch and hold to reorganize

### Search Bar

- Touch 1 to search by text
- Touch 2 to search by voice

# Home Screen, Apps and Widget

Learning the basics

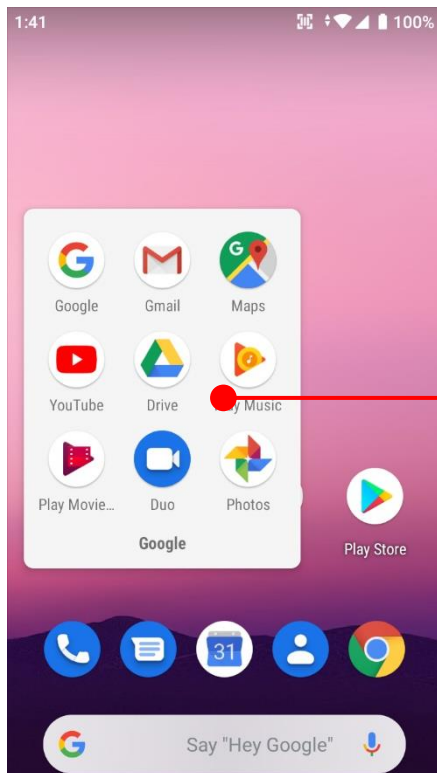

## To access App folder (Google App collections)

- Touch the app folder then you will see apps in the folder
- To change app folder's name, touch the bottom area of the App folder

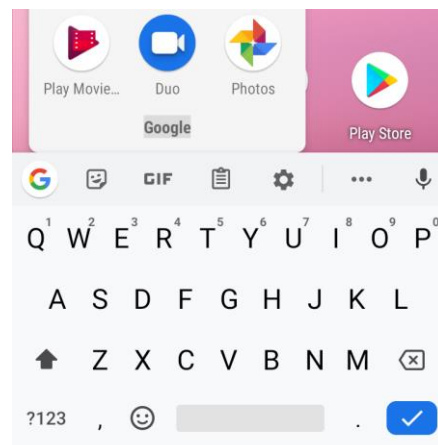

## To see App's option for quick access

- Long press the app icon. Then you will see options from the app. Here option may differ by app

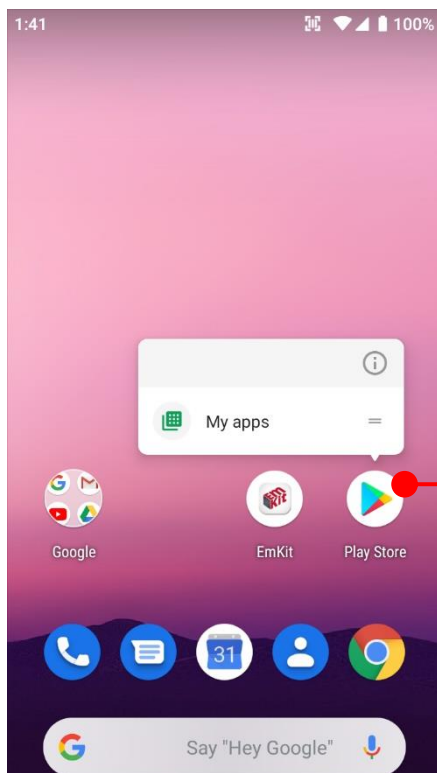

# Home Screen, Apps and Widget

Learning the basics

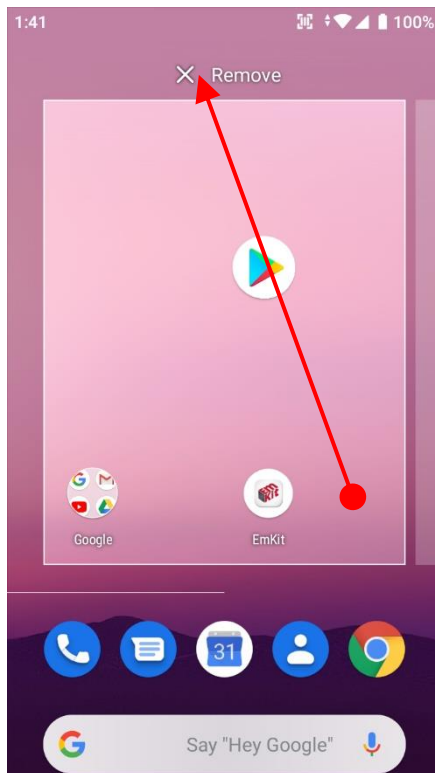

## Organize the app icon in the home screen

- Long-press drag the app icon and place where you want. You may place app icon to next panel
- If you want to remove the app icon, drag it to **Remove** area and release

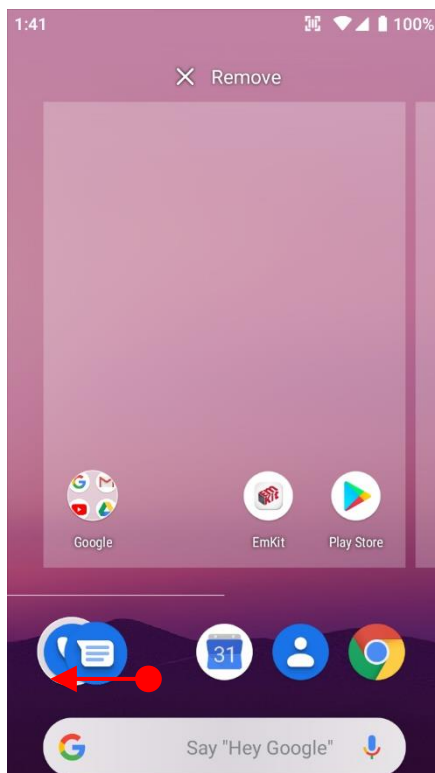

## Create "App Folder"

- Long press the app icon to another app icon. This will create the **App Folder**
- To set the folder name, touch the **Unnamed Folder** and rename it

# Home Screen, Apps and Widget

## Learning the basics

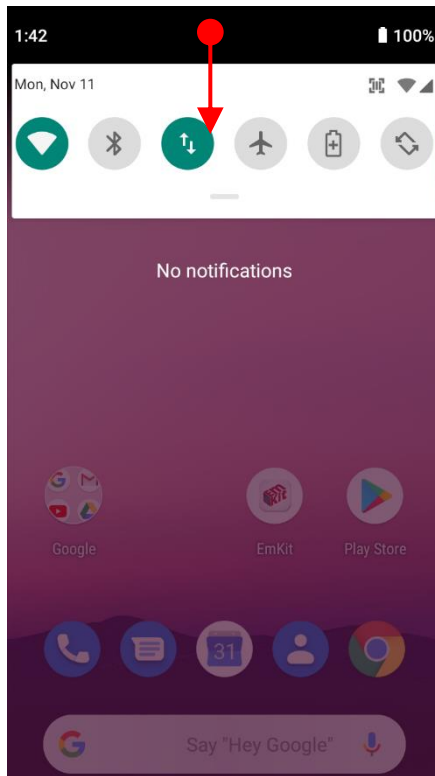

### Notification panel

When there is notification from the Android (system) or the App, you can check details by drag down the **Status Bar**.

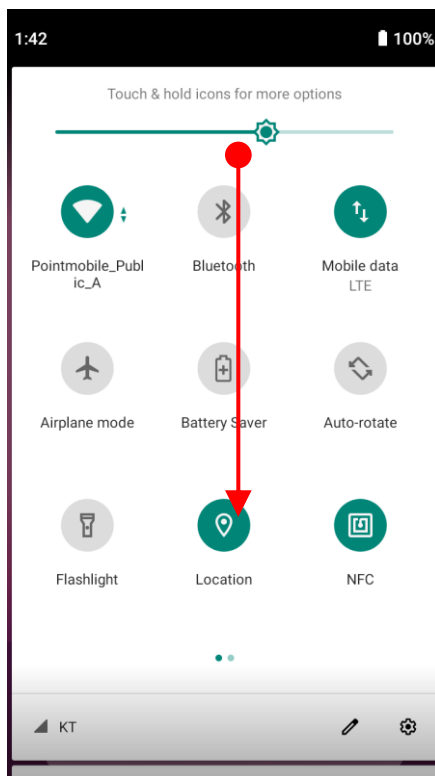

### Quick setting panel

You can access **Quick setting panel** by drag down the **Notification panel**. You can enable / disable system settings or change modes easily.

# Home Screen, Apps and Widget

Learning the basics

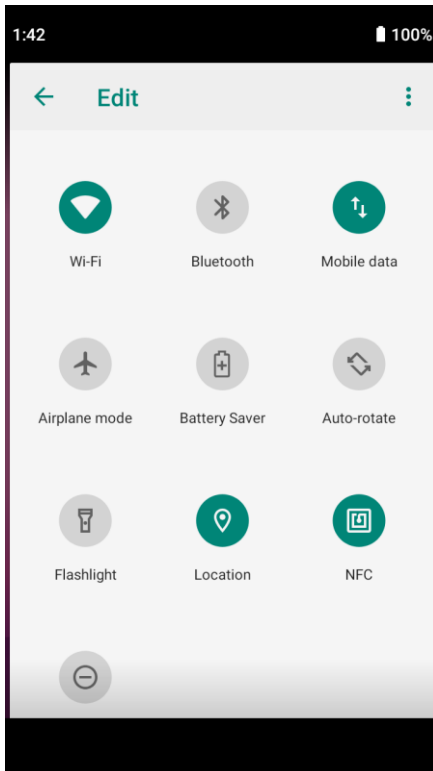

## Edit Quick settings panel

To change the order of icons in the **Quick settings panel** or add more icons, touch the  Edit icon

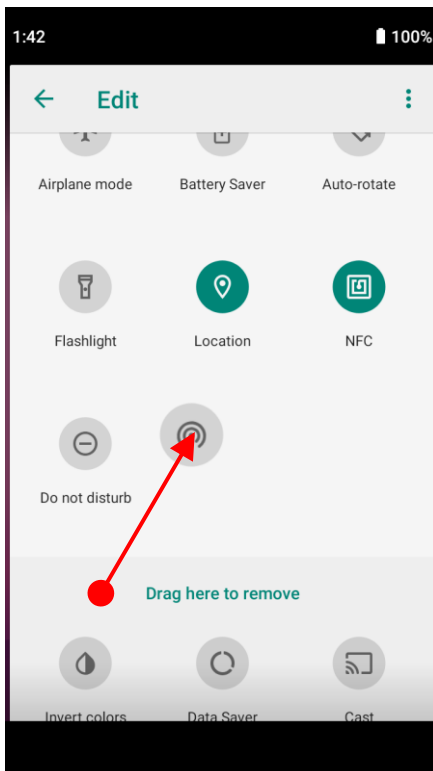

By dragging the icon, you can customize the **Quick settings panel**

# Home Screen, Apps and Widget

Learning the basics

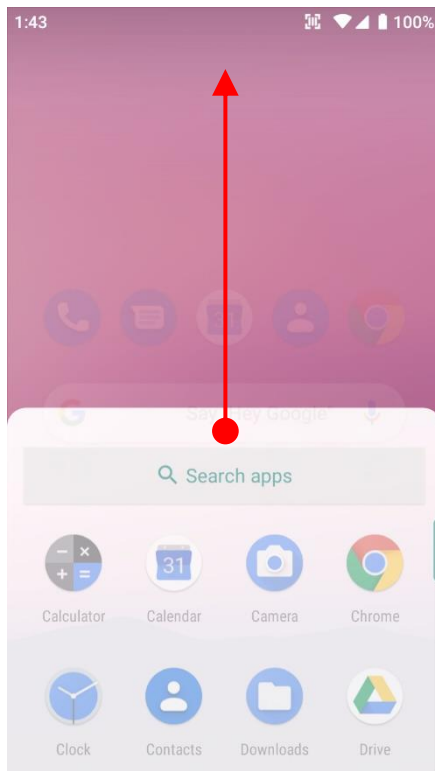
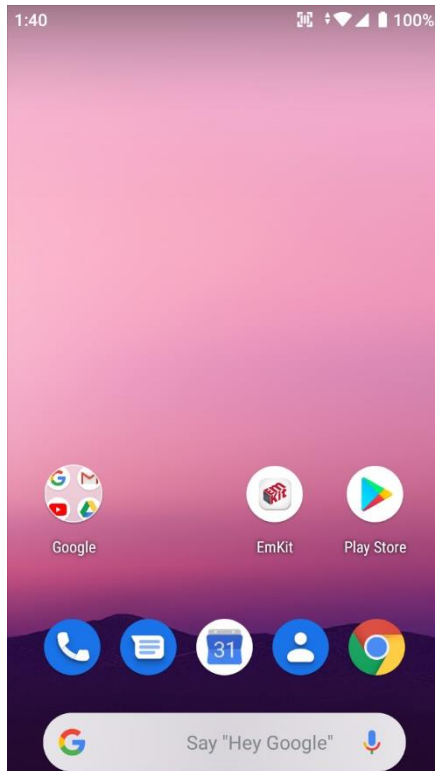

By **drag up** (swipe up) the Home Screen, you can access to app list in your PM90

# Home Screen, Apps and Widget

## Learning the basics

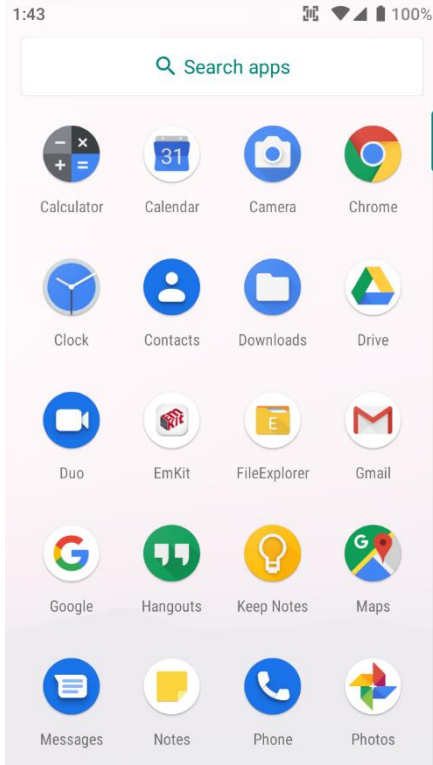

All installed apps are listed alphabetically

- Touch an app icon to run.
- Long press, specific app icon to place to the **Home Screen**.

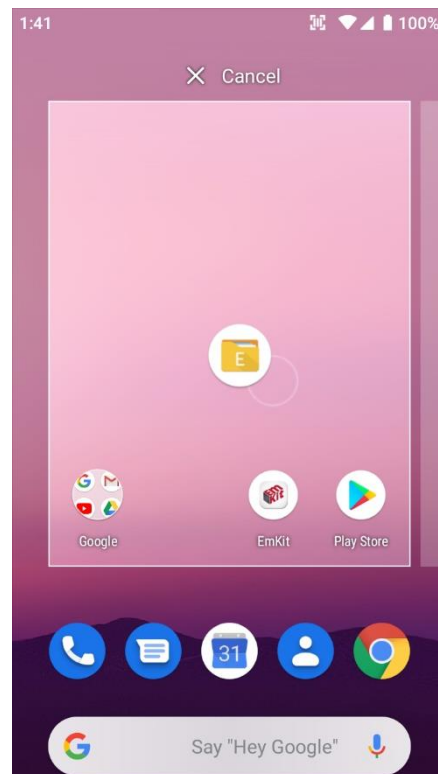

# Home Screen, Apps and Widget

## Learning the basics

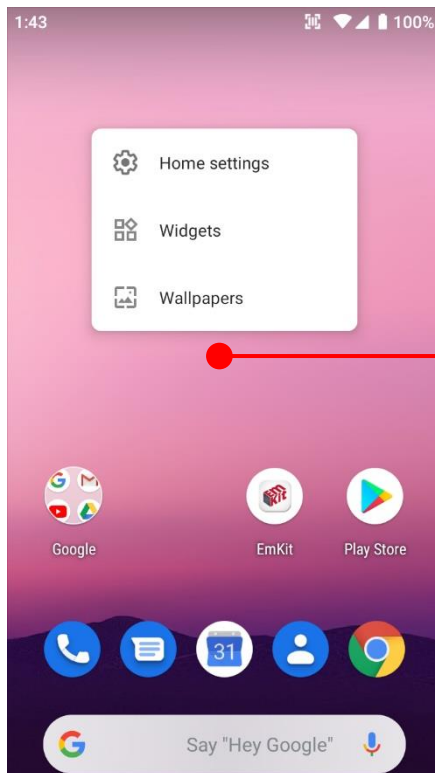

To add a Widget in the Home screen, long press the empty space. Then you will see **Home settings, Widgets, Wallpapers** menu. Touch **Widgets**

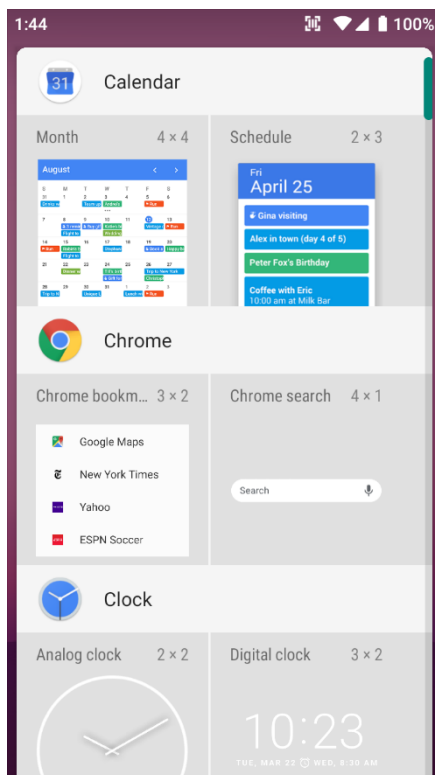



Available widgets are listed. Among the list select the widget which you want to add and place it to the Home screen by drag and drop

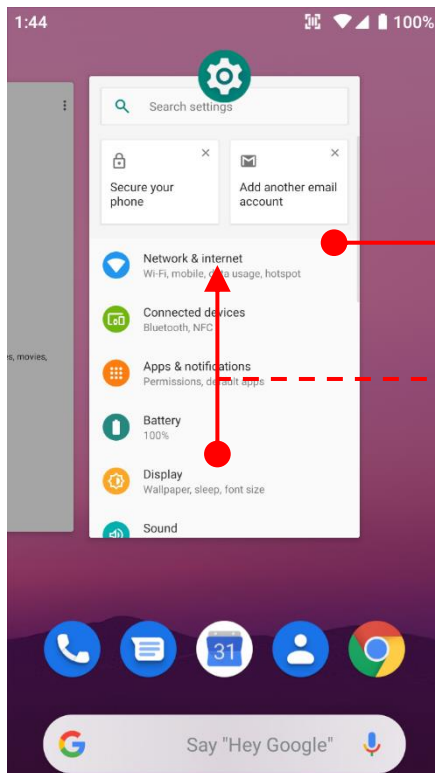

# Home Screen, Apps and Widget

Learning the basics



By pressing the  **Recent button** in the keypad, you can see app lists which you have been access

Touch the app, if you want to access again.

If you want to **Close** an individual app, **Drag up** (swipe up) the app

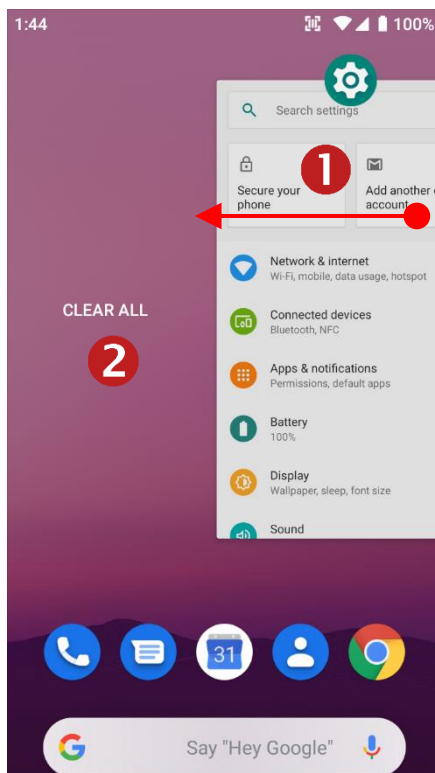

















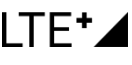







If you close all of the apps,

1. Drag (swipe) the recent app list
2. And then touch **CLEAR ALL**

# Status & Notifications Icons

Learning the basics

















## Status icons

	LTE connected		Strong signal
	3G connected		Good signal
	EDGE connected		Weak signal
	LTE+ (LTE CA) connected		Connection issue
	Data disabled		No data connection
	Airplane mode		Hotspot enabled
	Data communication		
	Wi-Fi turned on		Connected to a Wi-Fi network
	Connected to a Bluetooth device		
	Battery is full		Battery is partially drained
	Battery is low		Battery is very low
	Battery is charging		
	Location service turned on		Vibrate mode
	Speaker phone tuned on		Phone mic is mute

# Status & Notifications Icons

Learning the basics

## Notification icons

	Missed call		New SMS or MMS message
	New Email		Connected to VPN network
	Upcoming event		Alarm is set
	Preparing SD card		SD card removed, unexpectedly
	OTG device connected		Screenshot captured
	File uploaded		File downloaded
	File copied		
	Scanner turned on		
	There are more notifications		Other input method available

# Set a Lock screen

## Learning the basics

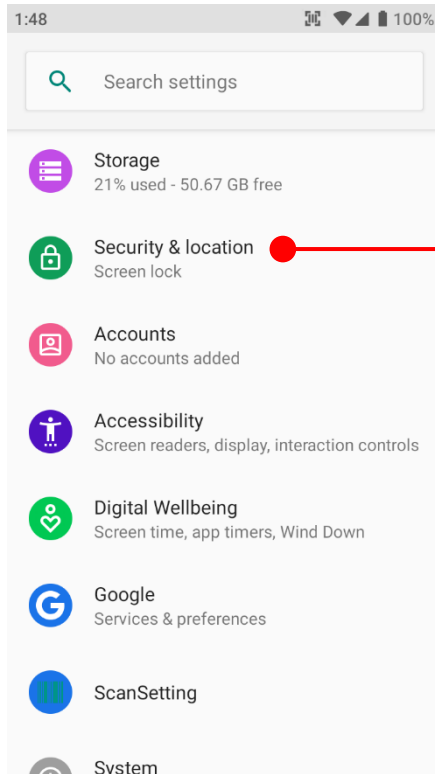

Settings  and then **Security & location**

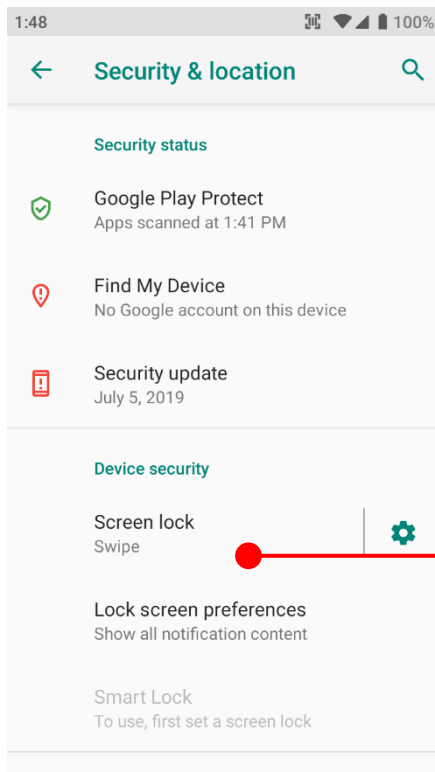

Touch **Screen lock**

You can see Screen lock type which is currently set. To change the screen lock, please touch the menu.

# Set a Lock screen

## Learning the basics

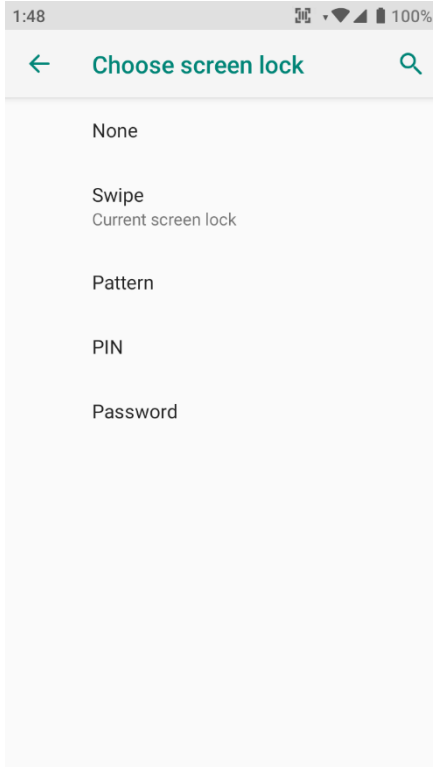

**None :** PM90 screen unlock immediately

**Swipe :** To unlock the screen, user should swipe the screen

**Pattern :** To unlock the screen, user draw the pattern

**PIN :** To unlock the screen, user should input the pin  
(Numbers. At least 4 digits)

**Password :** To unlock the screen, user should input the password  
(Numbers & Alphabet combination. At least 4 characters)

# Manage a display

## Learning the basics

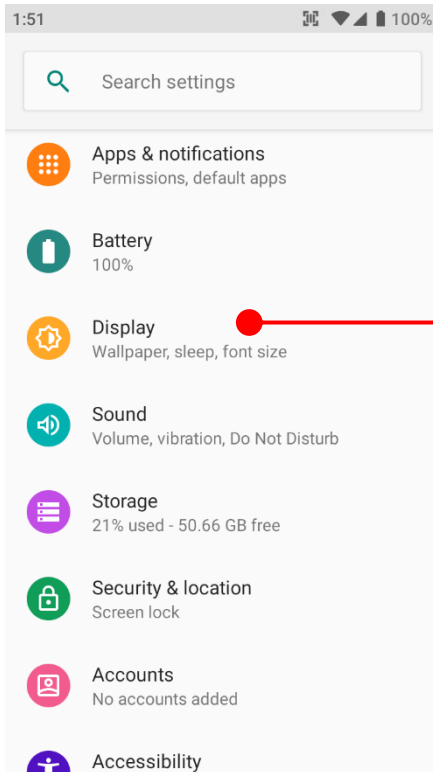

**Settings**  and then **Display**

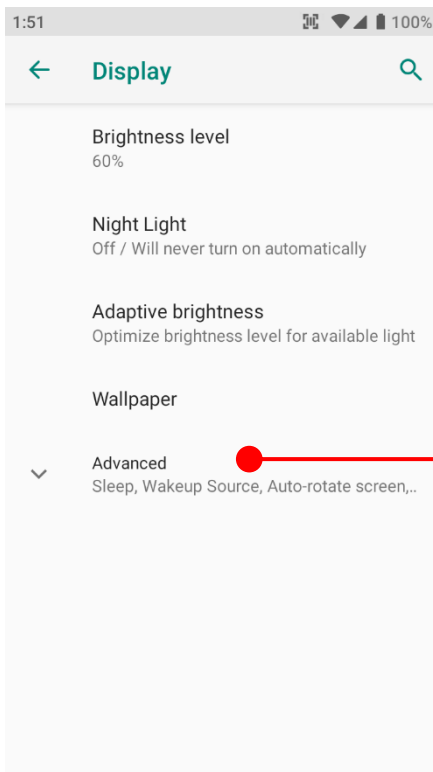

**Touch Advanced**

**Brightness level :** This setting changes the screen brightness level

**Night Light :** Set amber screen of PM90

**Adaptive brightness :** By enable this option, PM90 auto adjust the screen brightness

# Manage a display

## Learning the basics

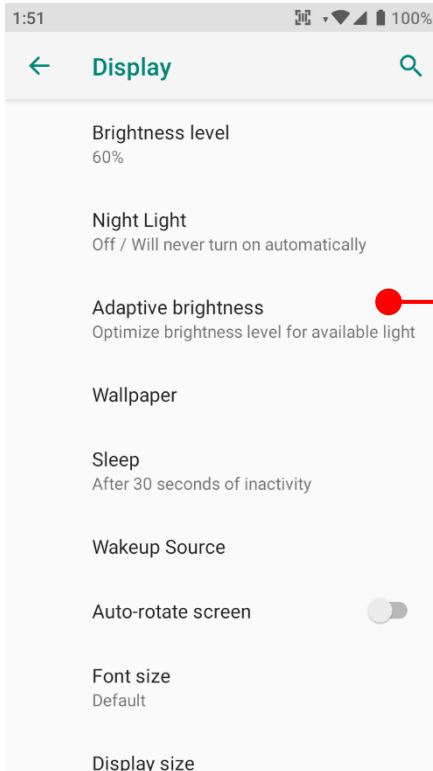

### Adaptive brightness

If you let PM90 auto adjust the brightness level, please enable this option

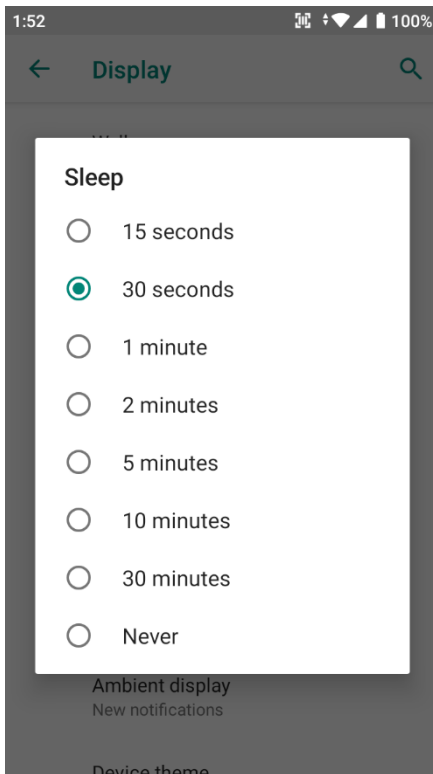
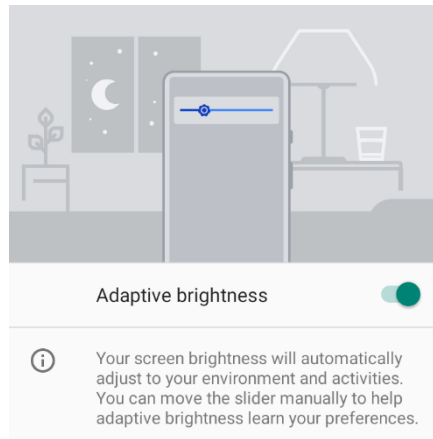

### Sleep

To change device sleep time, change option here

# Manage a display

## Learning the basics

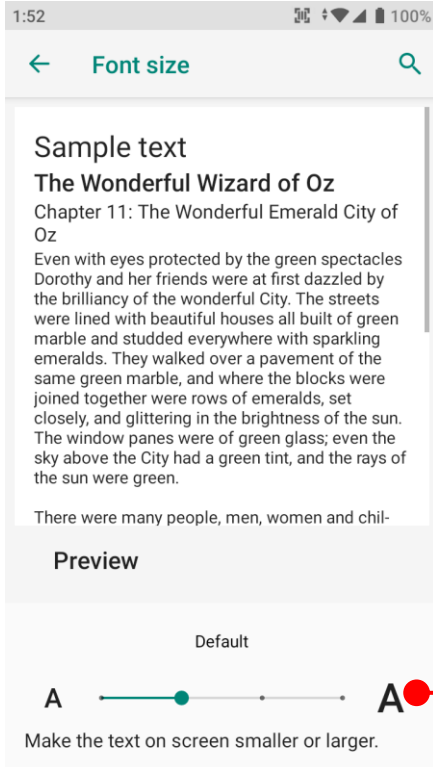

### Font size

Change the overall font size of PM90. Please adjust the slider

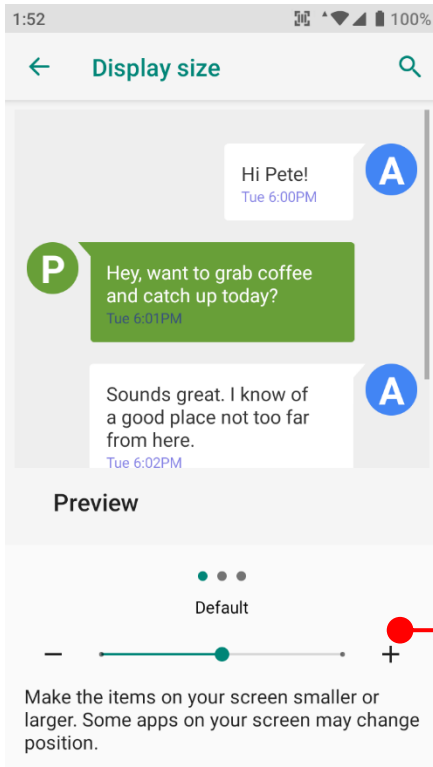

### Display size

Change the amount of the display item of PM90. Please adjust the slider



# Make a call

## Learning the basics

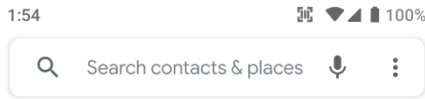

 icon in the favorite tray app drawer

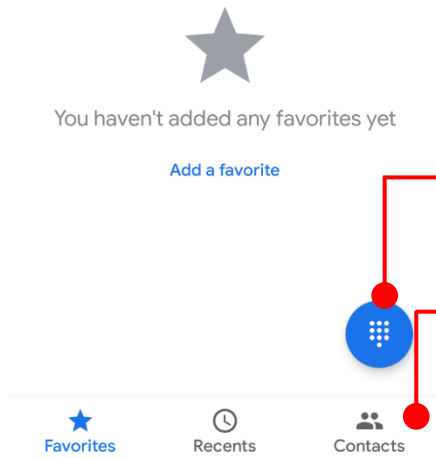

Touch to use a dialer

Touch to access the **Favorites**, **Recents** and **Contacts**.

- To make a call from recent call list or missed call, select **Recents** tab
- To make a call from your contact list, select **Contacts**



Suggested phone number(s)

**CONTACTS** save options

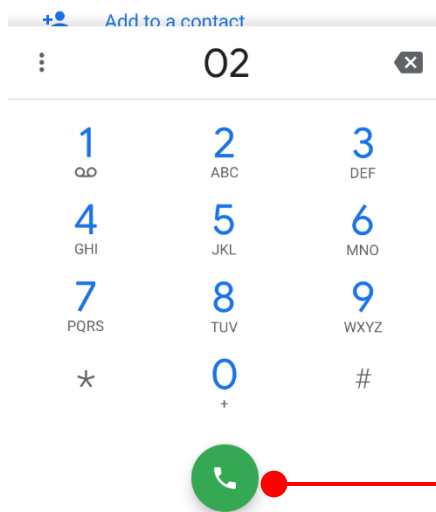

Touch to place a call

# Make a call

## Learning the basics

1:55     100%



Calling...

070-7090-2689

South Korea

Calling information



Mute



Keypad



Speaker

- Mute : Touch to mute the mic
- Keypad : Touch to input keypad during a call
- Speaker : Touch to make a speakerphone call



Add call



Touch to end a call

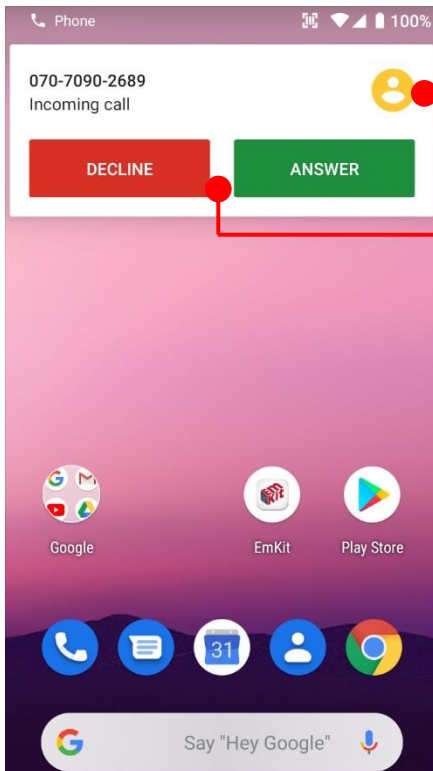

Caller information

DECLINE

ANSWER

- Decline : Touch to refuse a call
- Answer : Touch to answer a call

**Tip:** To mute the ringtone volume of an incoming call, press the Volume down or Volume up key

# Add to a contact

## Learning the basics

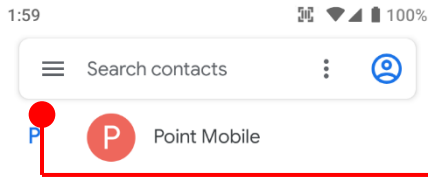

Touch  icon in the Favorite tray apps

Touch to see Contacts options



Touch to add a new contact

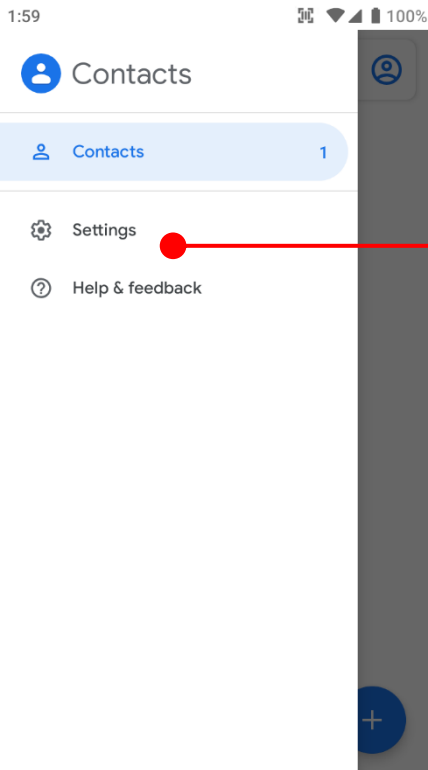

Touch to set more detail settings

# Add to a contact

## Learning the basics

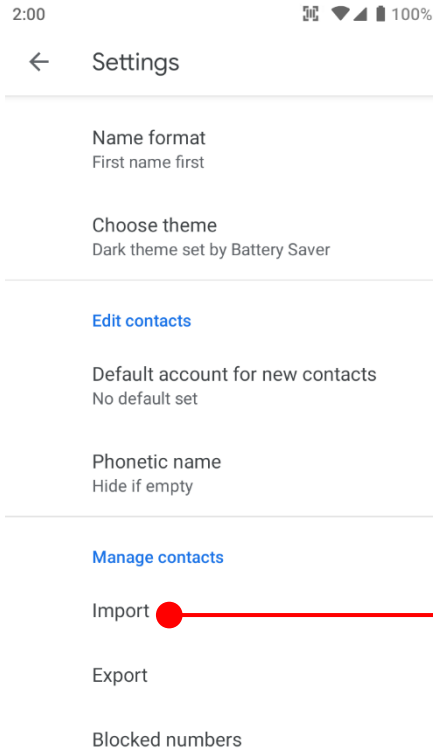

Touch to import contact information from vcf (vCard) file or SIM card

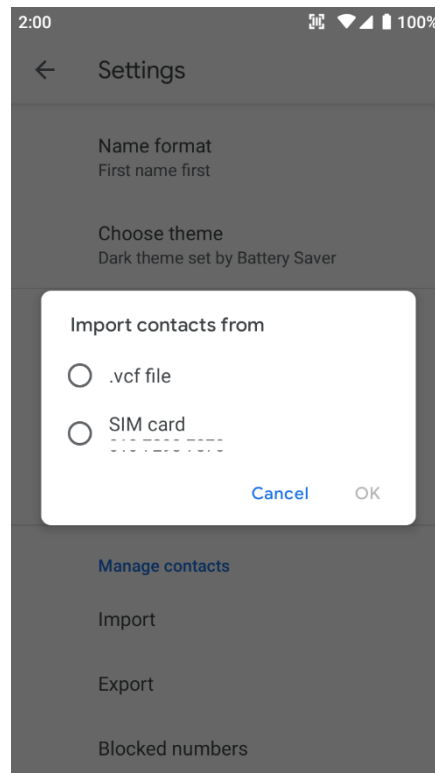

# Connect to your Wi-Fi network

Learning the basics

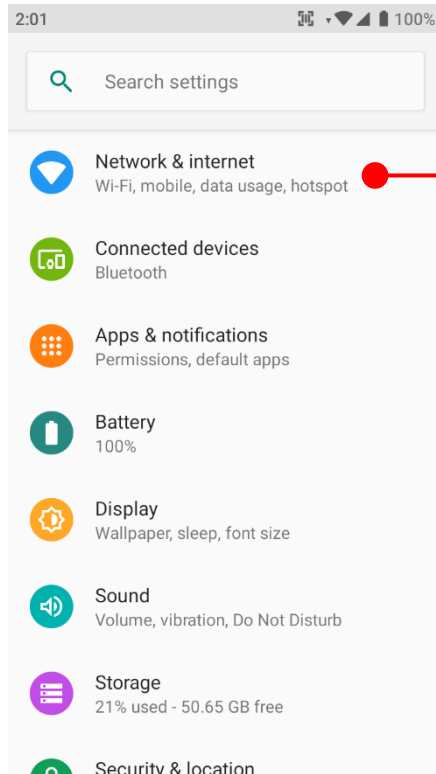

**Settings** → **Network & Internet** and then **Wi-Fi**

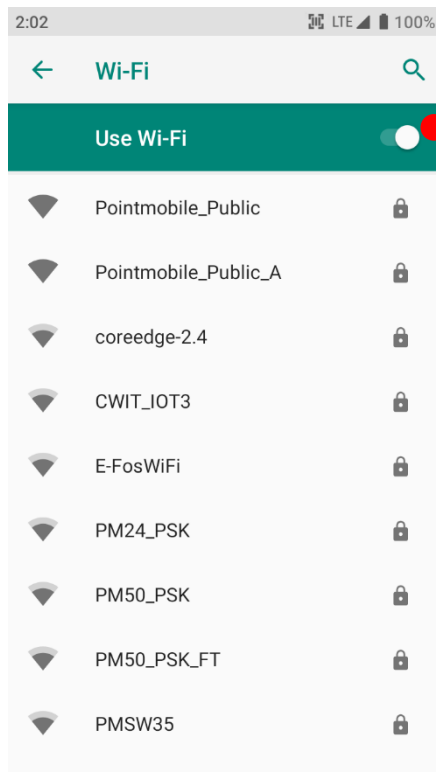
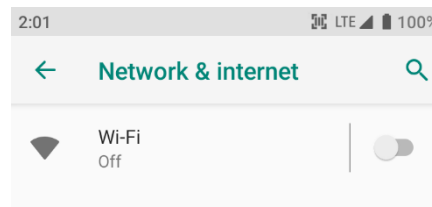

Touch to turn On/Off the W-Fi

You can see nearby Wi-Fi network.  
Each AP's SSID information listed by signal strength

🔒 Icon means : Secured Wi-Fi network. To connect this Wi-Fi network, you need to enter the password

# Connect to your Wi-Fi network

## Learning the basics

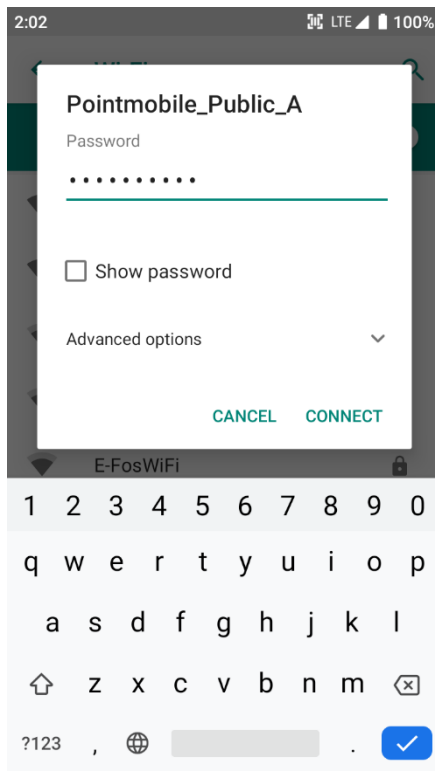

Touch SSID, which you want to connect.  
To connect to the secured Wi-Fi network, enter the password

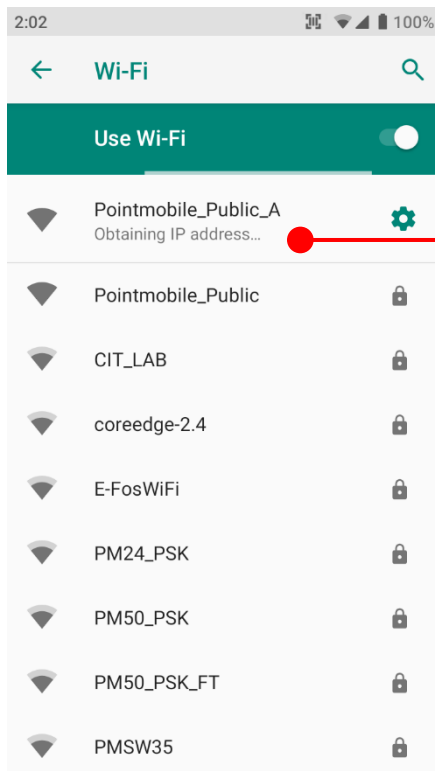

PM90 is obtaining the IP address from the selected AP

# Make a Wi-Fi hotspot

## Learning the basics

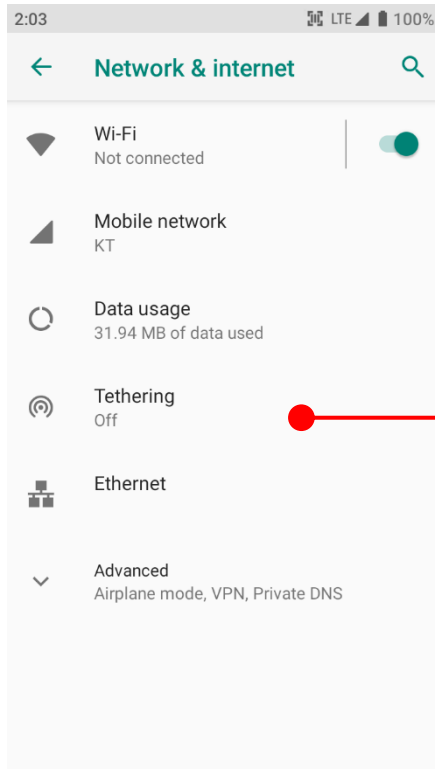

**Settings** → **Network & Internet** and then **Tethering**

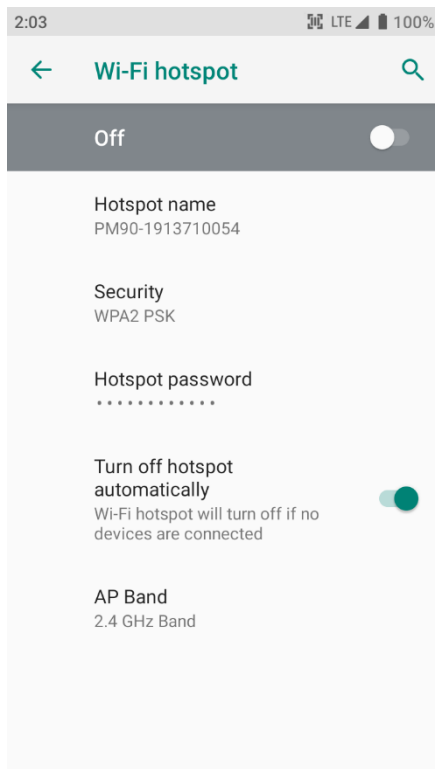
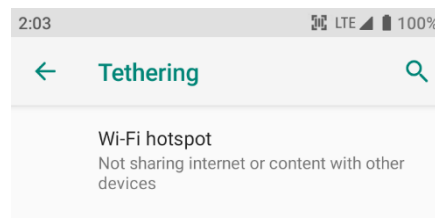

You can change W-Fi hotspot option here.  
Hotspot SSID name, Security option, Hotspot Password and Hotspot's Band

# Connect with Bluetooth device

Learning the basics

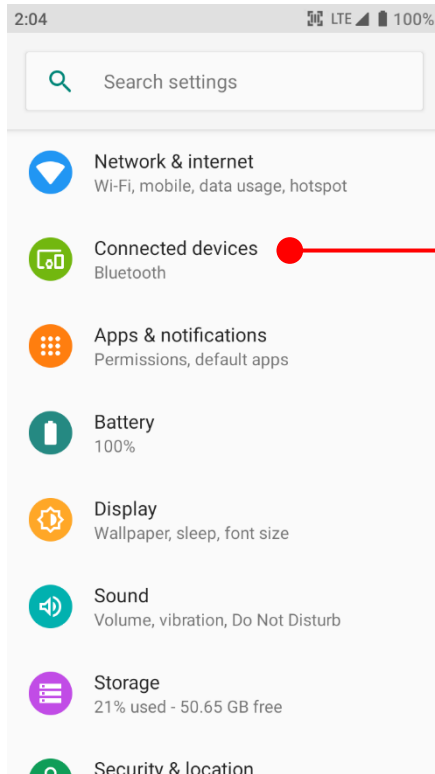

Settings  and then **Connected devices**

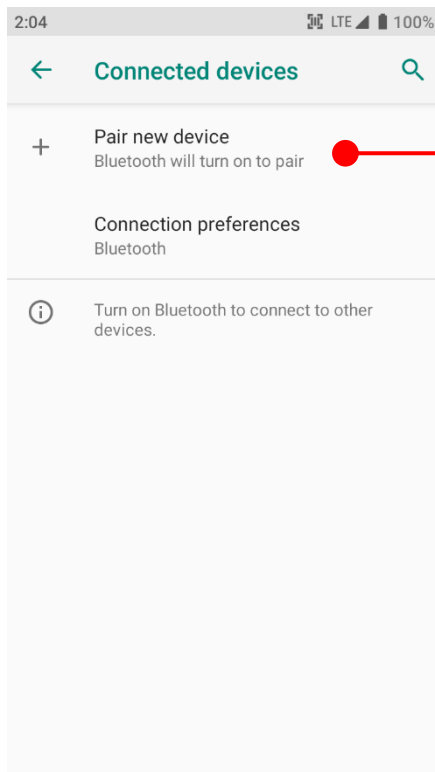

Touch **Pair new device**



## Connect with Bluetooth device

### Learning the basics

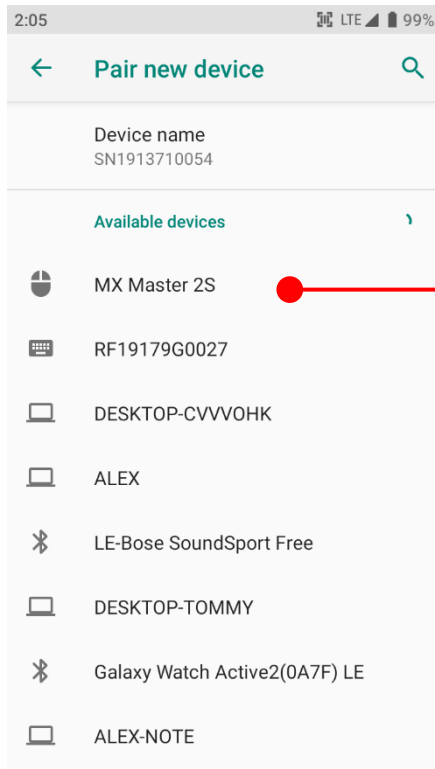

PM90 will list up nearby Bluetooth devices. Touch to make a pairing (You may input the password)

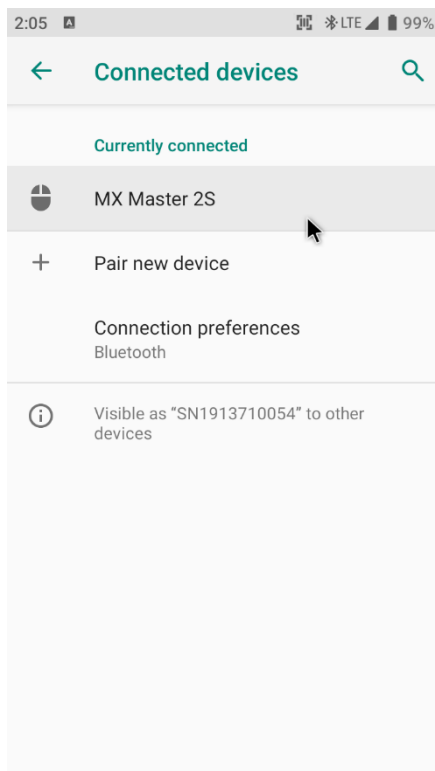

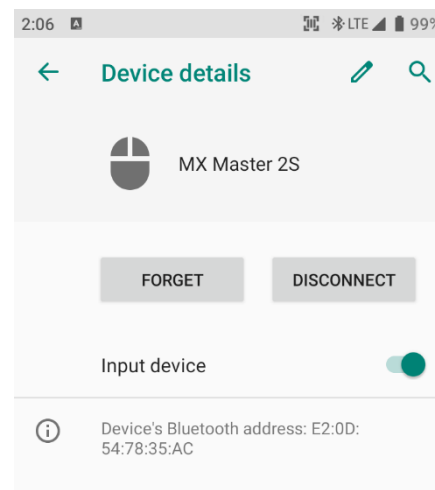

Bluetooth device is connected with PM90.  
Touch the device for advanced setup

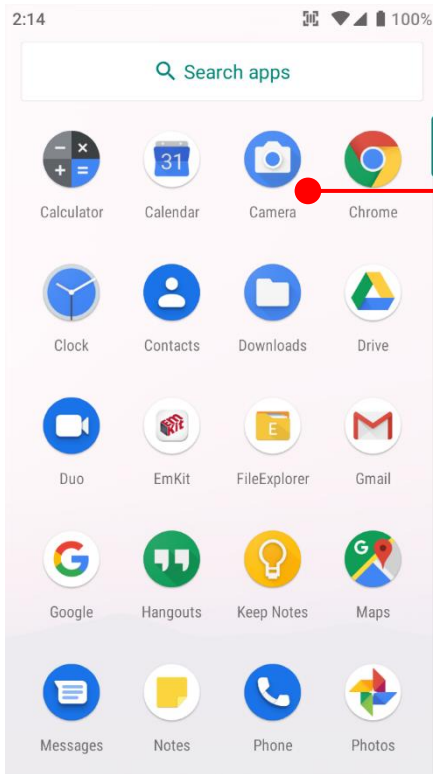

# Use a Camera

## Learning the basics



Navigate to **App list** and then Camera app 

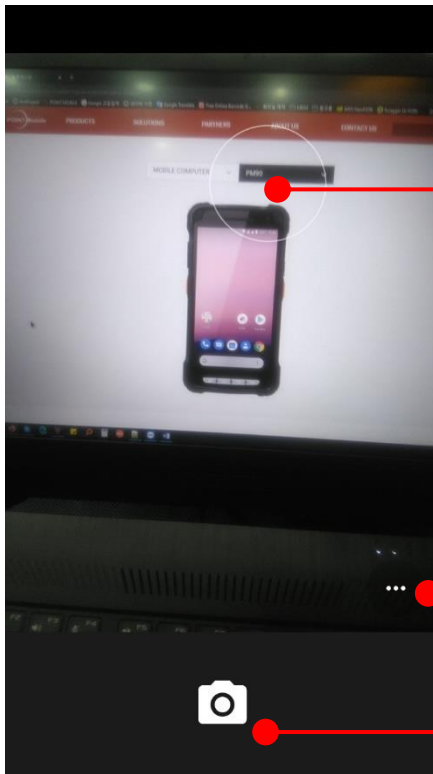

Auto focusing area. You can change the focusing area by touching the other area

Touch for Camera / Video option

Take a picture or recode a video

# Use a Camera

## Learning the basics

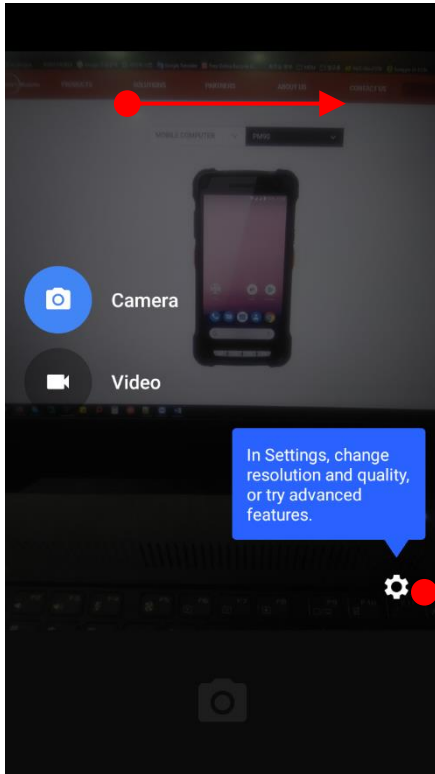

Swipe to change the Camera / Video mode or access to Settings

Settings

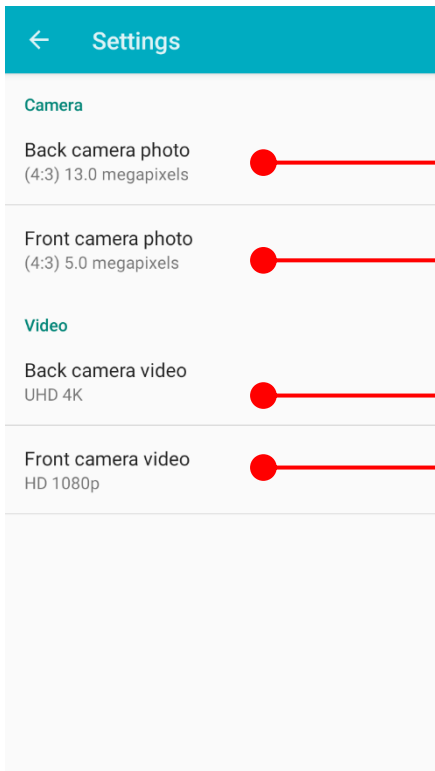

Set rear camera image saving quality

Set front camera image saving quality

Set rear camera video saving quality

Set front camera video saving quality

# Manage files and folders

## Learning the basics

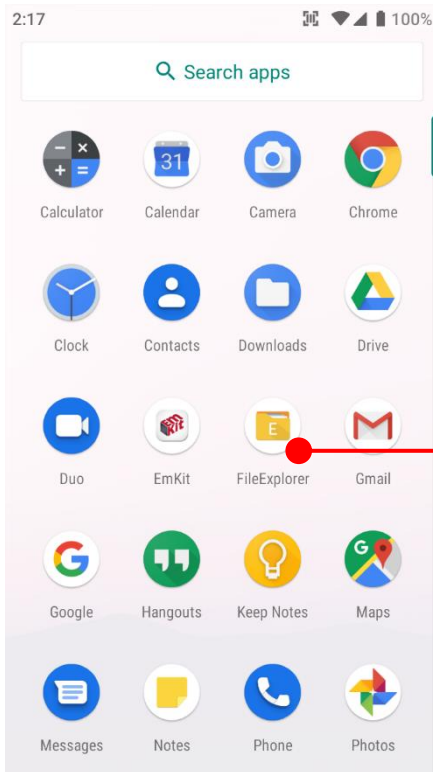

Navigate to **App list** and then File Explorer app 

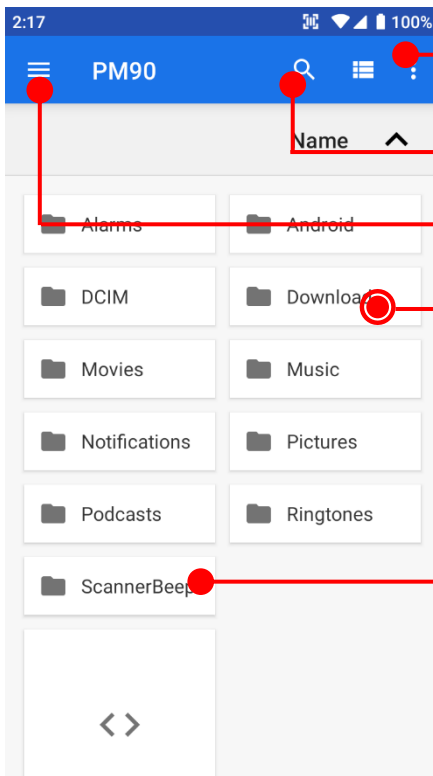

Touch for advanced menu

File search

Select media file type or storage

Long tap to select a file or folder

Touch to navigate folder / open the file or install an apk file

# Manage files and folders

## Learning the basics

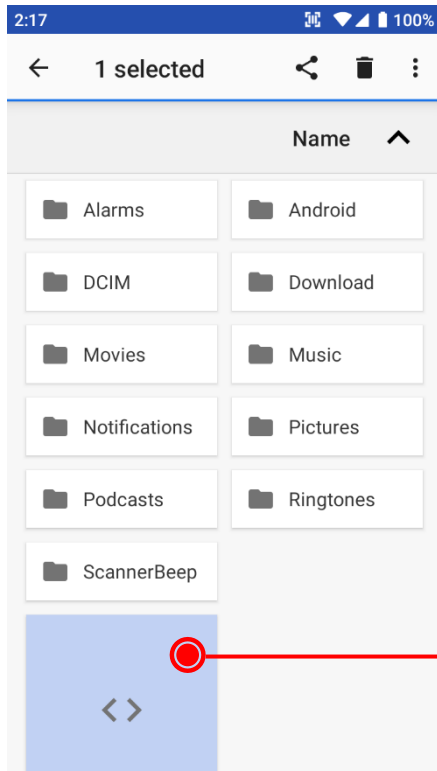

Long tap the file and touch option icon  in top-left corner

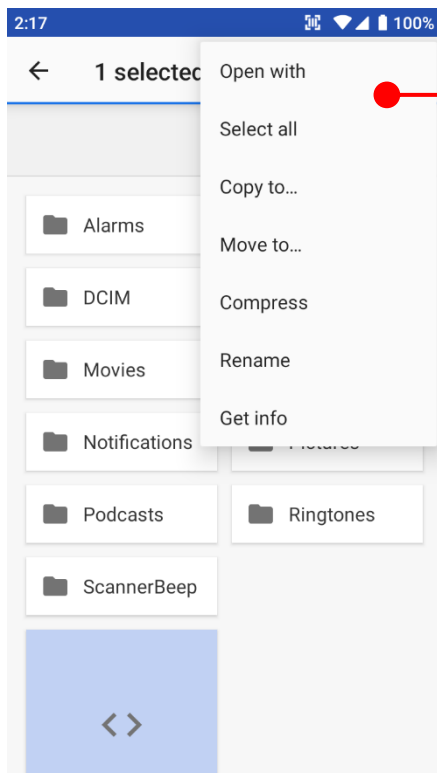

Now you can copy and move to specific folder or rename the file or folder

# Manage files and folders

## Learning the basics

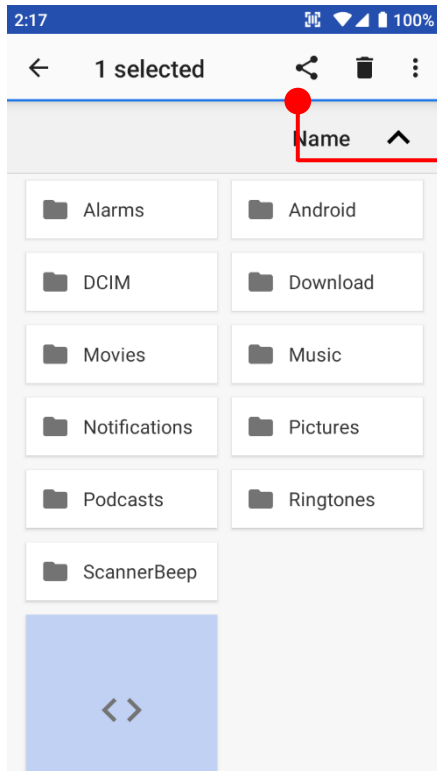

### Share a file

Long tap the file and touch share icon  in the menu

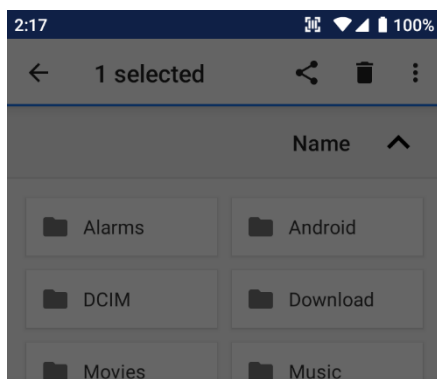

Share via



Now you can share selected file to nearby device or attach to Gmail or upload to Google Drive. Manual describe Android Beam sharing via NFC

# Manage files and folders

## Learning the basics

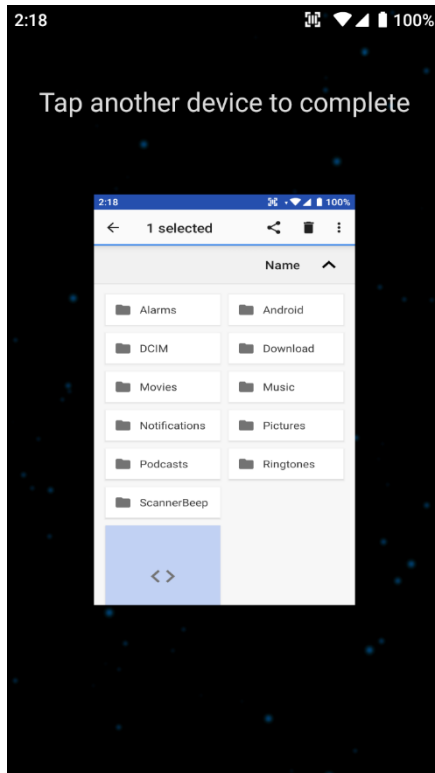

Now tag another device to PM90  
PM90 will transfer the file

# Manage files and folders

## Learning the basics

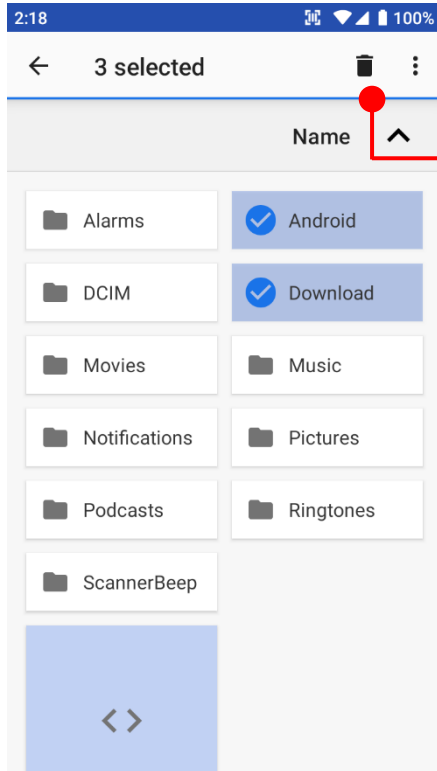

### Delete files

Long tap the file and touch delete icon  in the menu

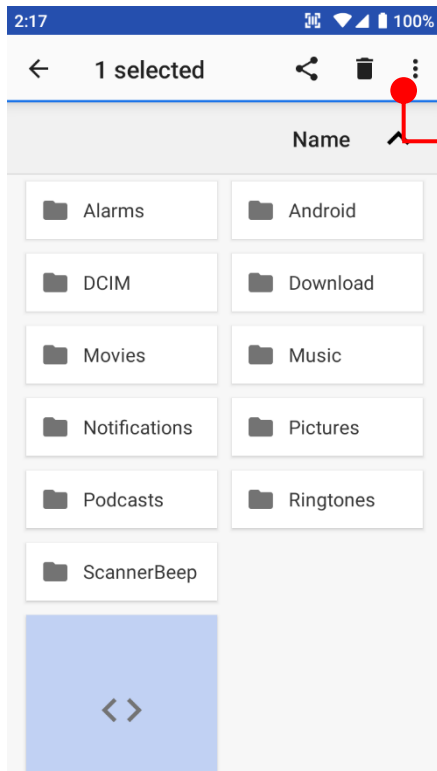

### Copy or move files

Long tap the file and touch option icon  in top-left corner



# Manage files and folders

## Learning the basics

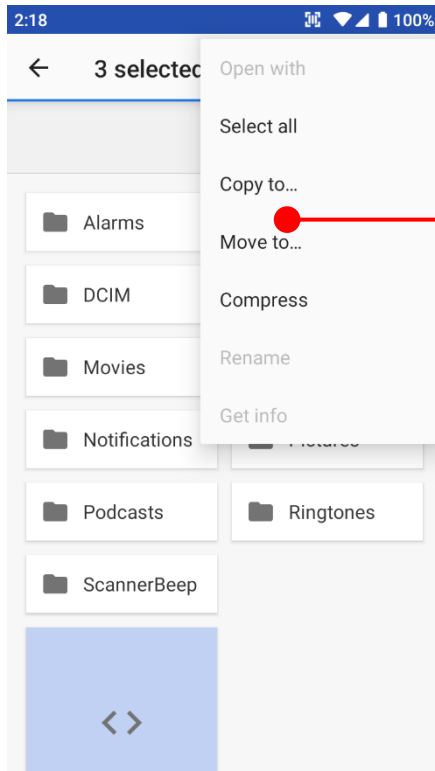

Touch **Copy to...** or **Move to...** in the menu

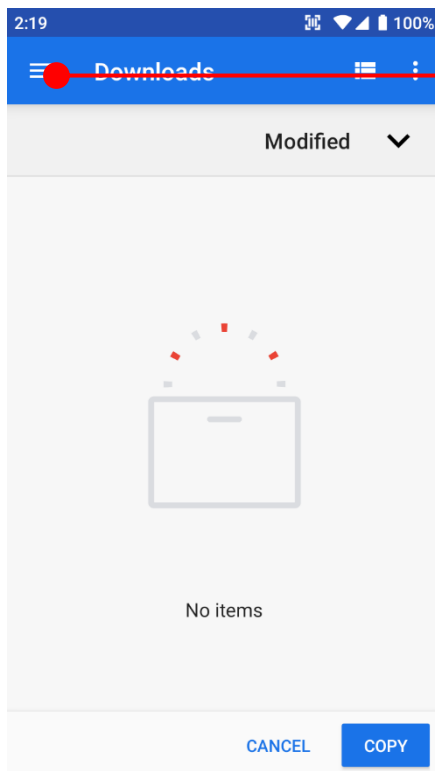

Touch menu icon ≡ to navigate file location

# Manage files and folders

## Learning the basics

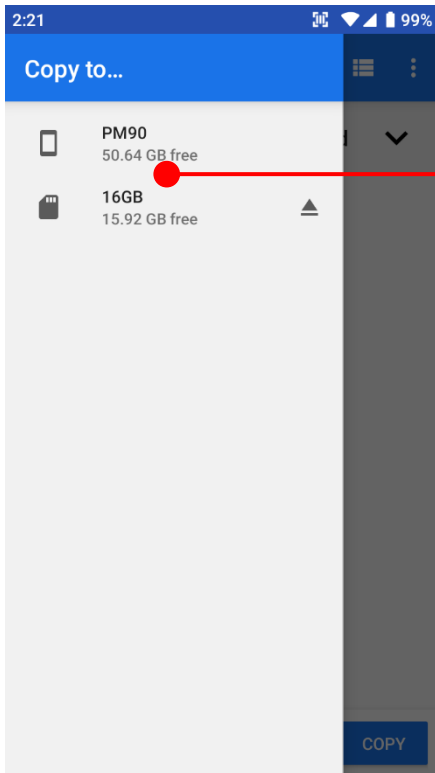

Touch the storage where copy or move to

**Note:** Please format the SD card as FAT32 and make sure set the label as below screenshot from the computer

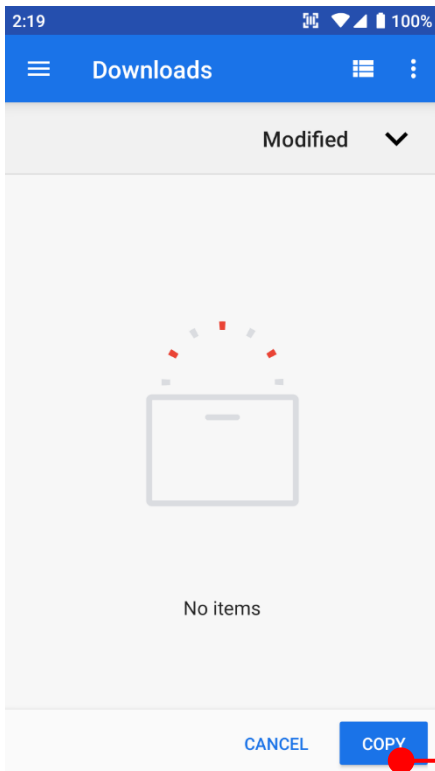
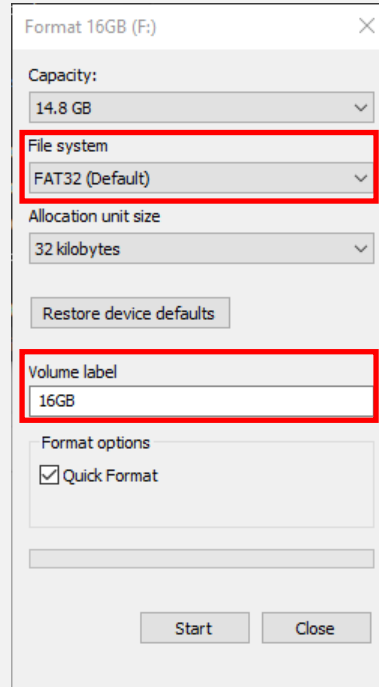

Touch **COPY**

# MTP connection with PC

## Learning the basics

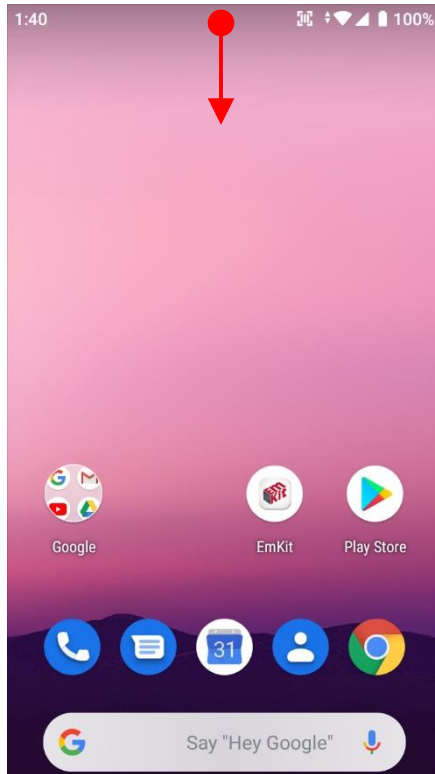

To browse files and folders in the PM90 in your PC, please change USB connect option

Scroll down the **Status Bar**

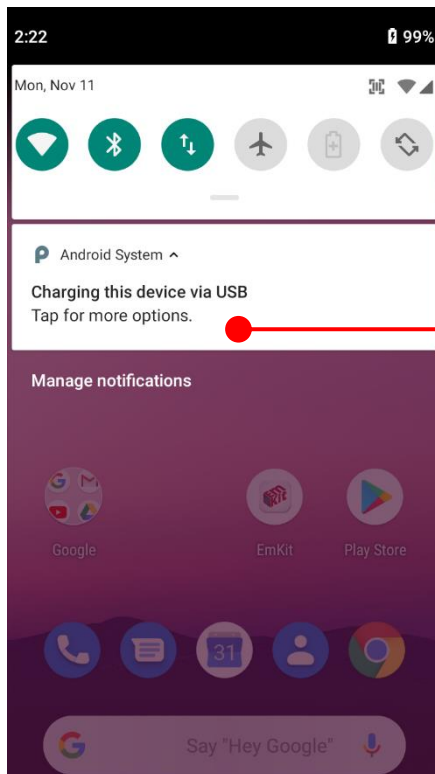

Touch USB connect option

# MTP connection with PC

Learning the basics

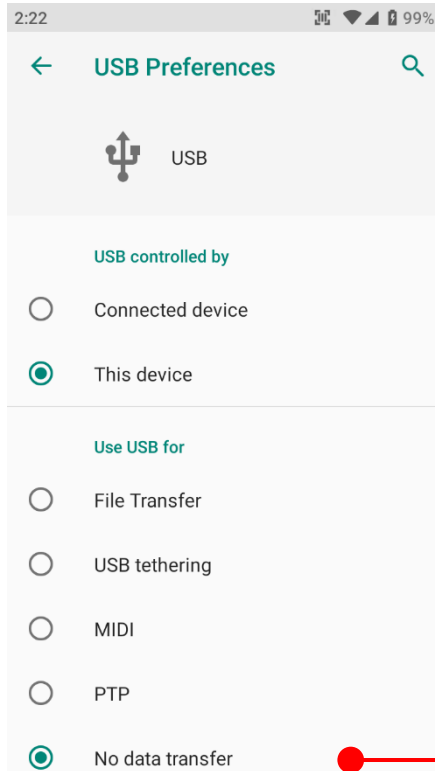

Change option to **File Transfer** from **No data transfer**

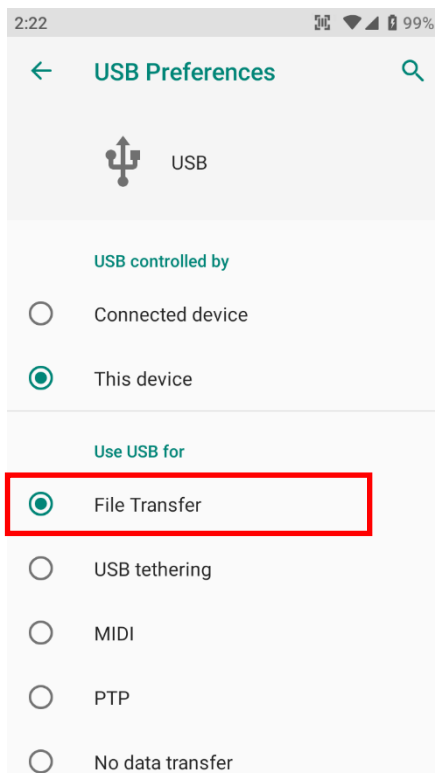

Now your PC recognize PM90 as MTP device

# MTP connection with PC

Learning the basics

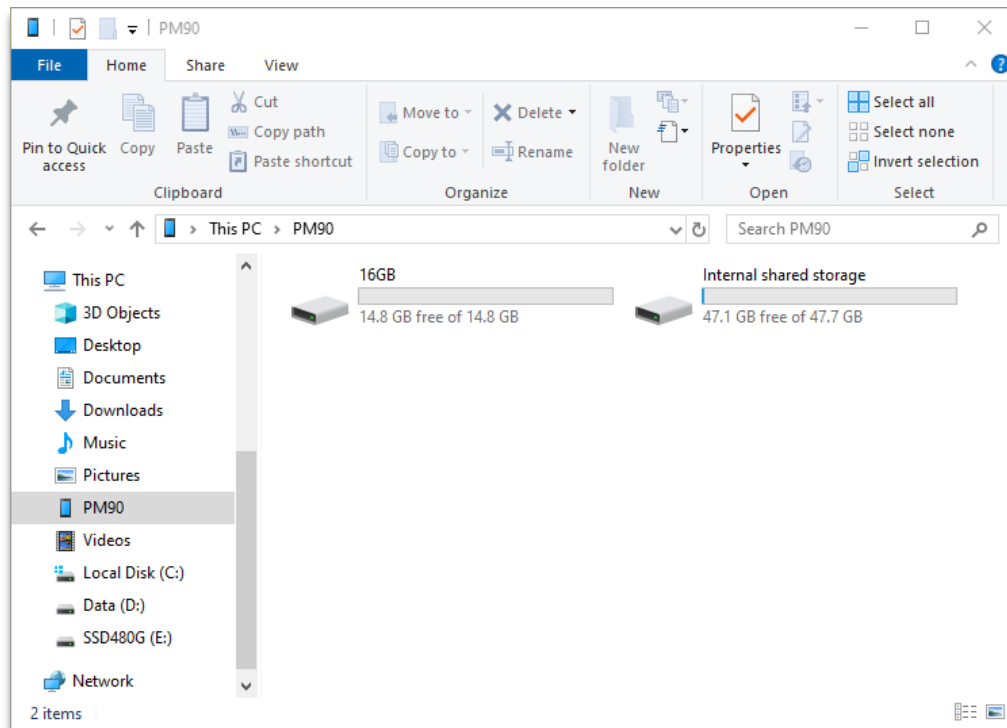
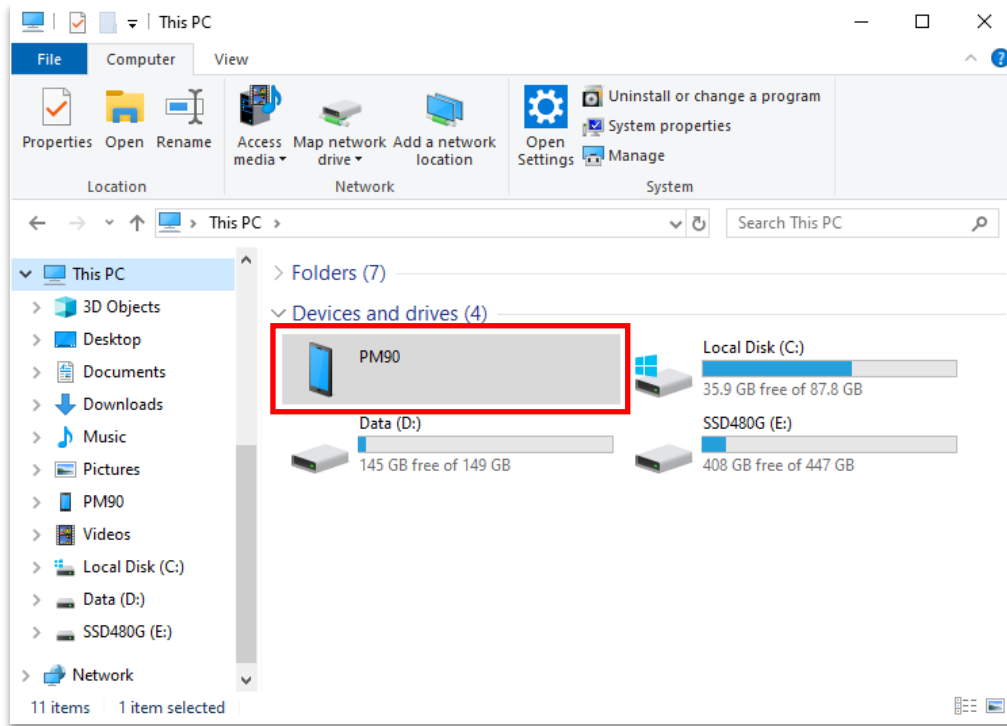

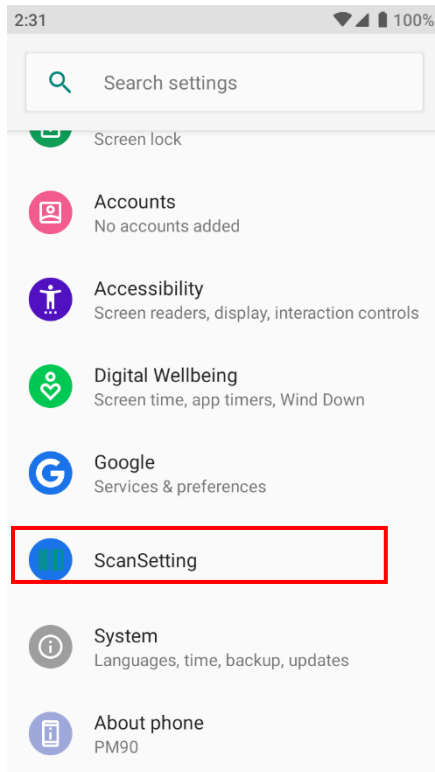

# Use a Scanner

## Scanner Settings



Default setting of Scanner is **Off**

To use the Scanner,

- Touch  EmKit and then **ScanSetting**
- **Settings**  and then **ScanSettings**

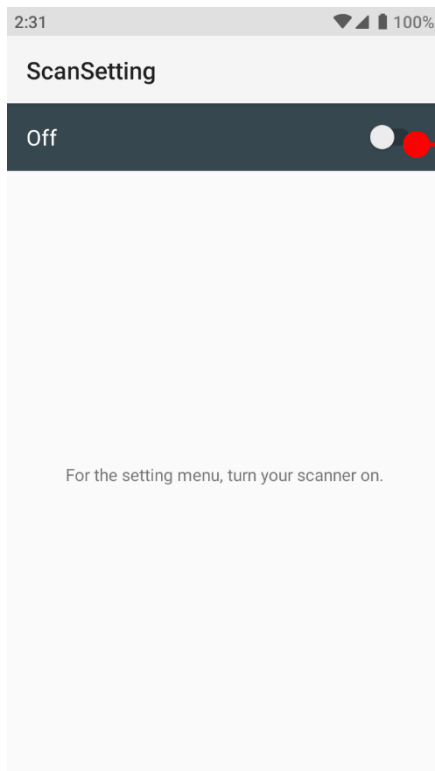

Touch to turn on the Scanner

# Use a Scanner

## Scanner Settings

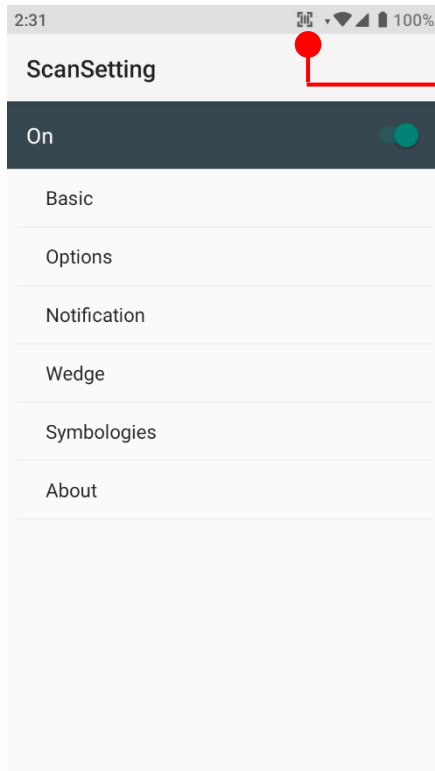

Now you can see **Scanner Wedge** icon in the **Status Bar**

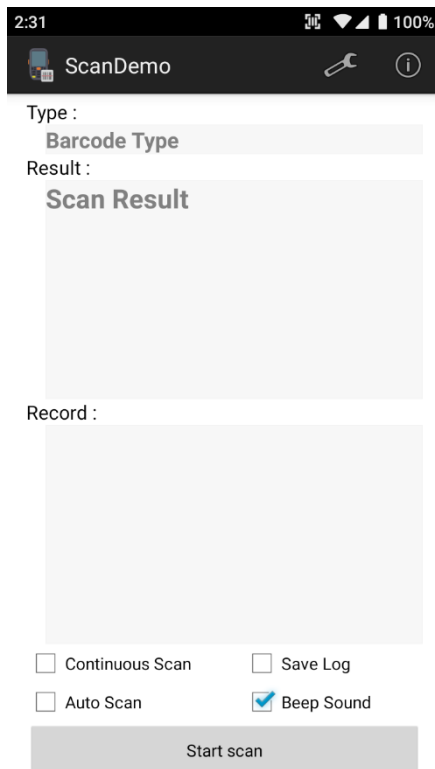

**Note:** When “Scanner” turned on, you can scan the barcode with **ScanDemo** in the **EmKit**

# Use a Scanner

## Scanner Settings

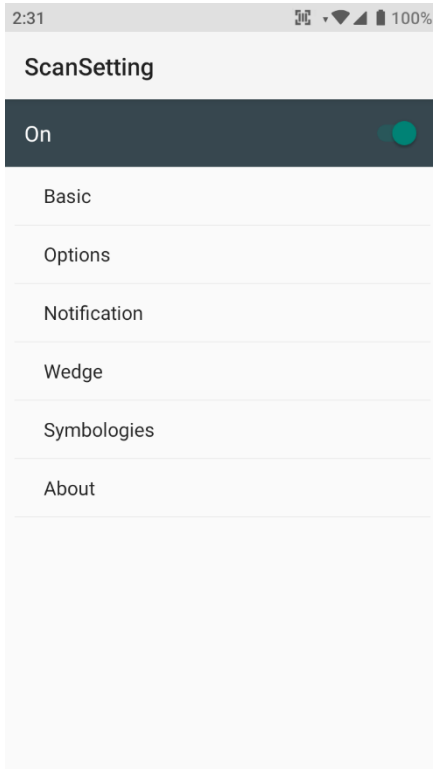

### Scanner setting details

Scanner setting consist with **Basic**, **Options**, **Notification**, **Wedge**, **Symbologies**, and **About**

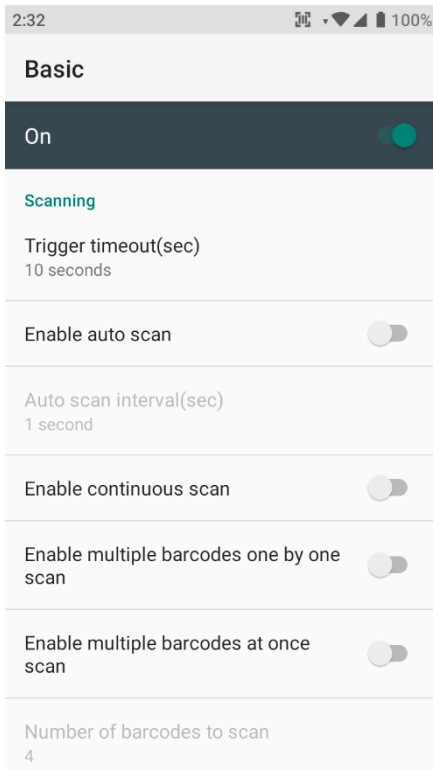

In the **Basic**, you can set **Scanning** option and **Wedge mode** option

In the **Scanning** option, you can change Scanner's **Trigger timeout** and set **Auto scan** & **Continues scan** options



# Use a Scanner

## Scanner Settings

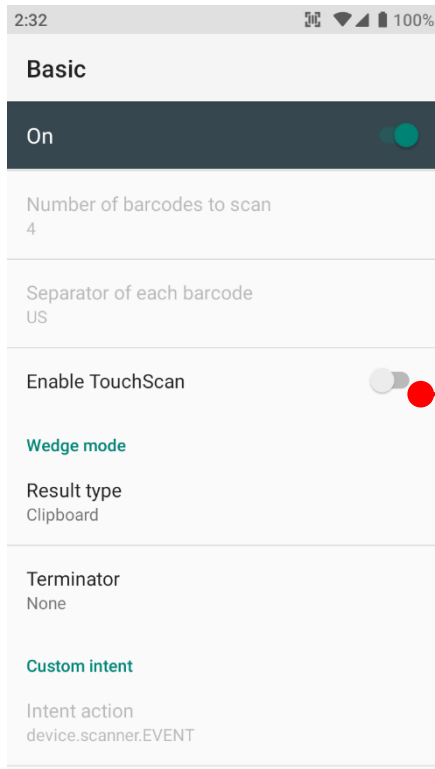

**TouchScan** is software scanner button.  
Touch to enable this function

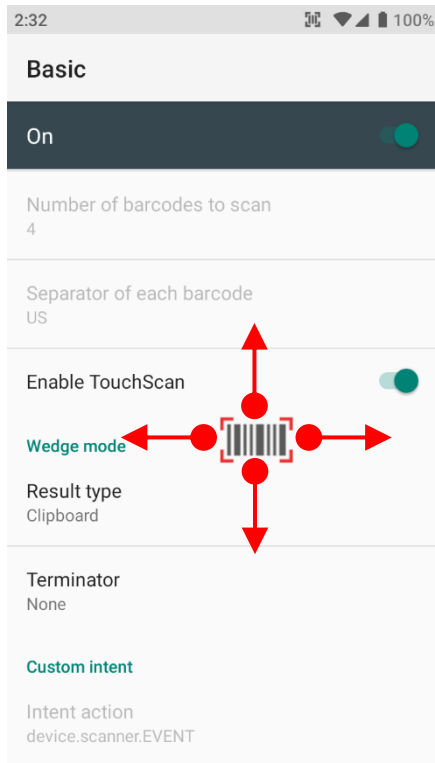

You can place **TouchScan** icon any position.  
Touch the icon to read a barcode.

## Use a Scanner

## Scanner Settings

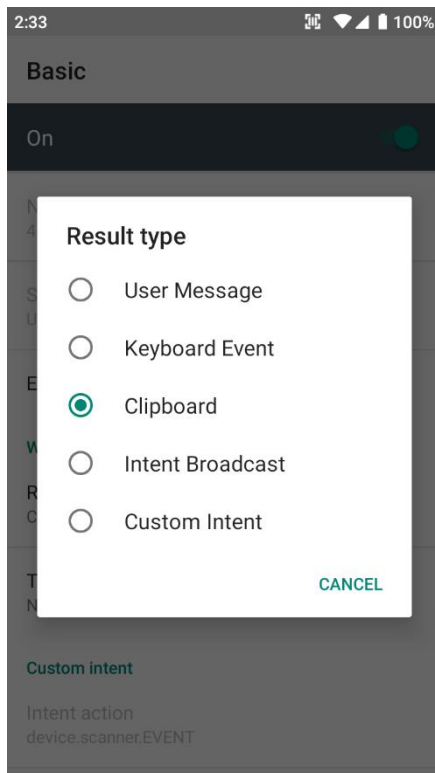

In the **Wedge menu** you can change, decode scan data's result type handling **User Message**, **Keyboard Event**, **Clipboard**, **Intent Broadcast** or **Custom Intent**

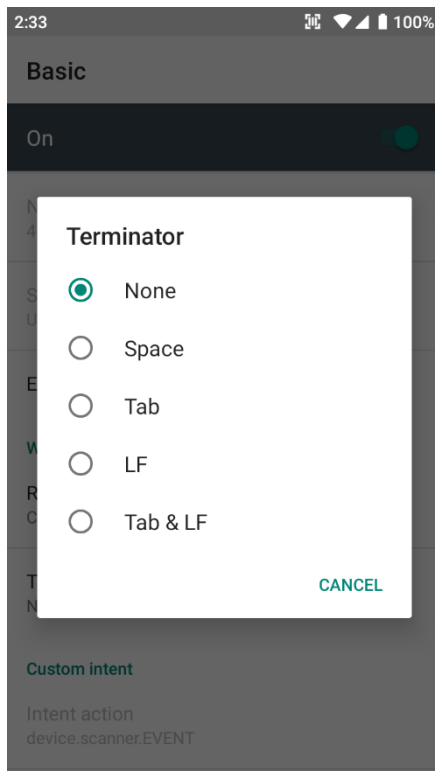

Also, you can set Terminator as **None**, **Space**, **Tab**, **LF** or **Tab & LF**

## Use a Scanner

## Scanner Settings

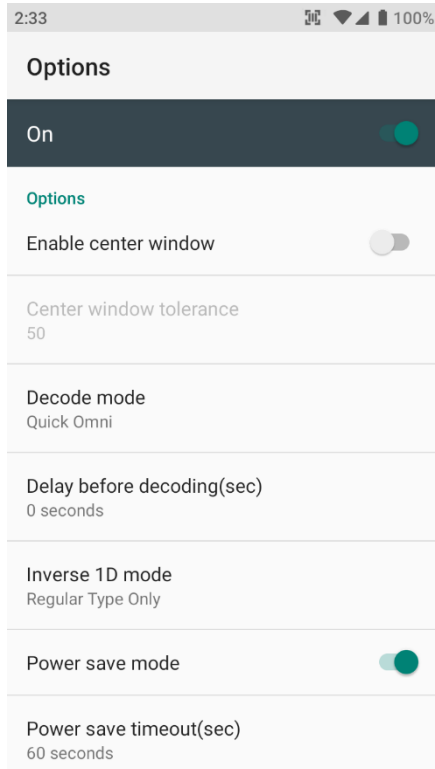

In the **Options**, you can enable/disable the **Center Window**, set **Decode mode**, **Power save mode** and enable/disable **Aimer & Illumination** option

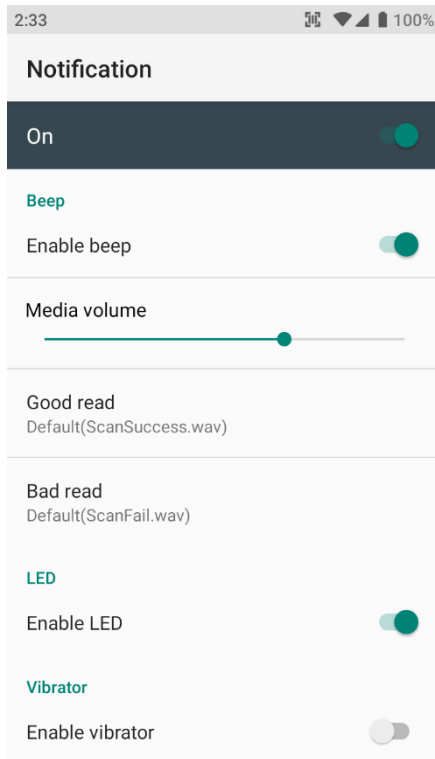

In the **Notification**, you can change the volume level, notification sound, LED and vibration option

## Use a Scanner

## Scanner Settings

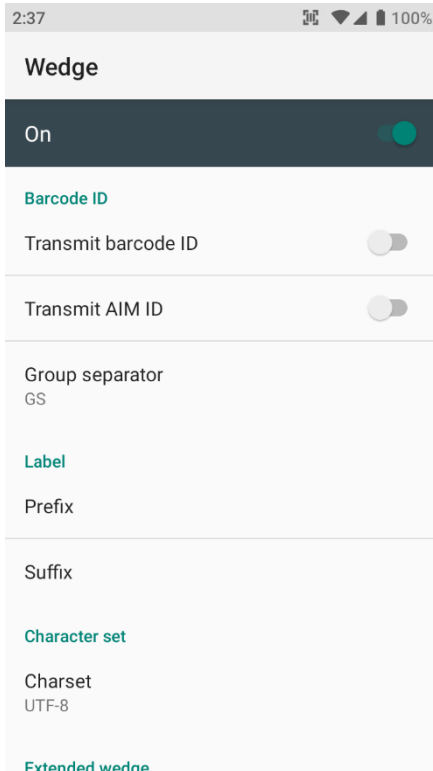

In the **Wedge**, you can enable/disable **Barcode ID** and **Aim ID**, set **Group separator**, **Prefix & Suffix**, **Character set** and **Extended Wedge**.

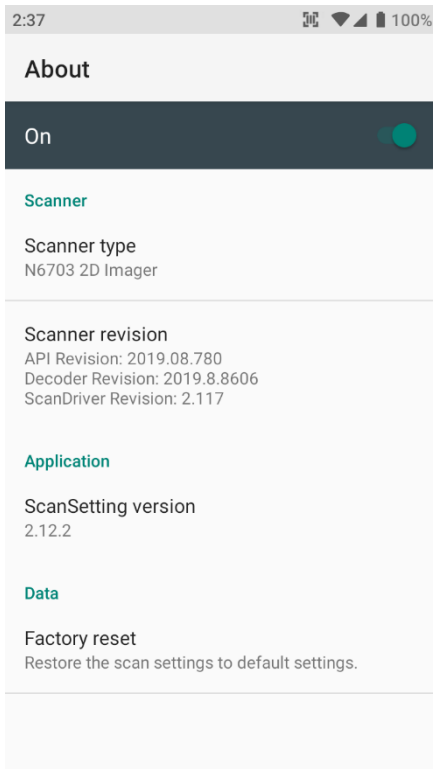

In the **About**, you can check your Scanner's information and restore Scanner's settings to default

# Scan a Barcode

## Scanner Settings

### Example of good Barcode reading



Idle barcode scan  
Please aim the middle of barcode



Even you aim the barcode slightly upper or down area or angle is slightly tilted, you can read the barcode



## Scan a Barcode

## Scanner Settings

### Example of bad Barcode reading



If you aim the barcode wrong direction or tilt too much, you can't read the barcode



If you aim part of Barcode or aim two barcodes together, you can't read the barcode

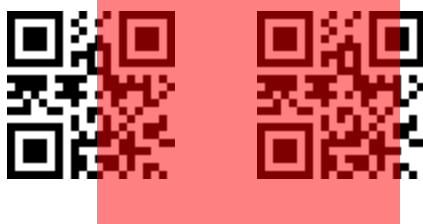

# OS Image update from a Storage

## OS Update

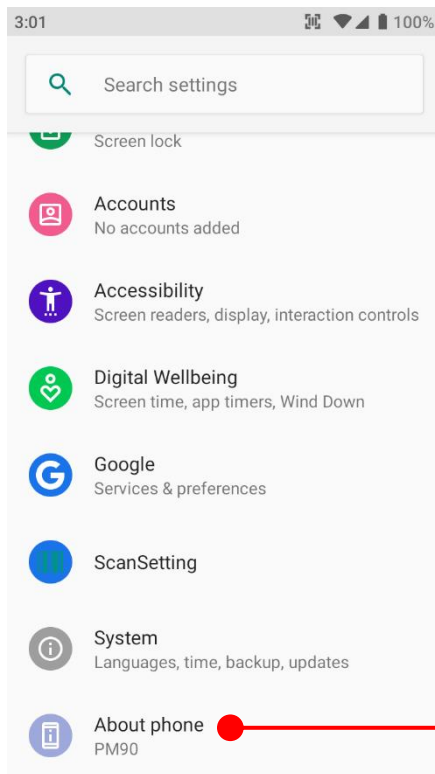

**Note:** To update OS image, copy or place OS image file into the **root folder** of “Internal Storage” or “External Storage”

**Settings**  and then **About phone**

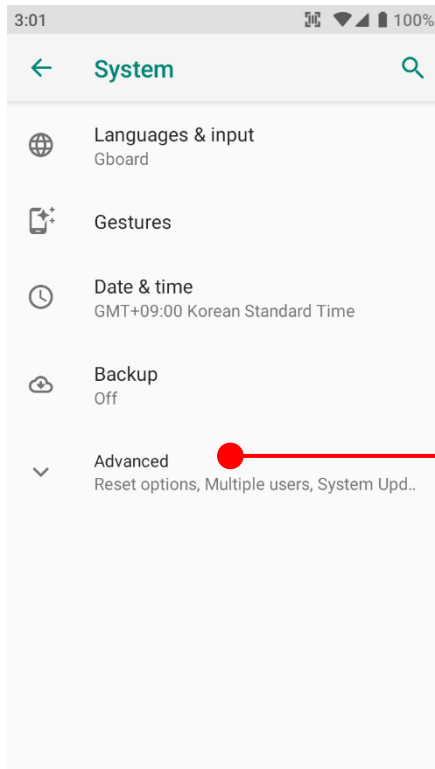

**Touch Advanced**

# OS Image update from a Storage

## OS Update

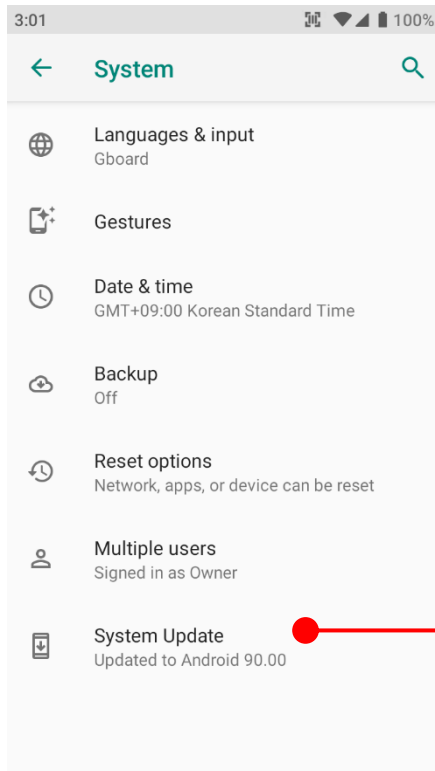

Touch **System Updates**

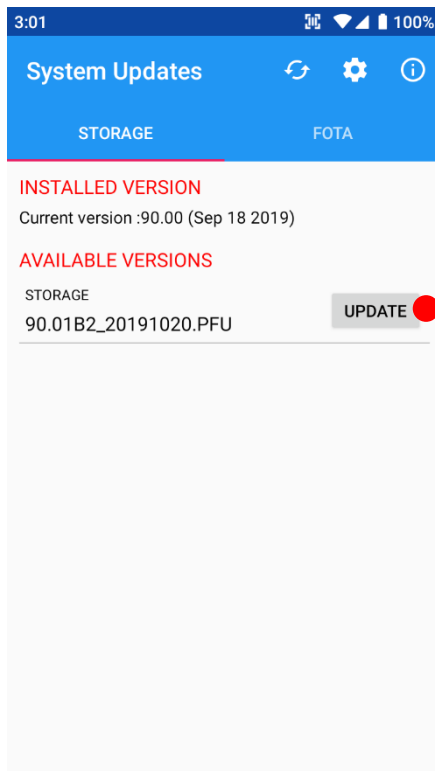

Your PM90 will check storage and display available OS image. Touch **UPDATE**



# OS Image update from a Storage

## OS Update

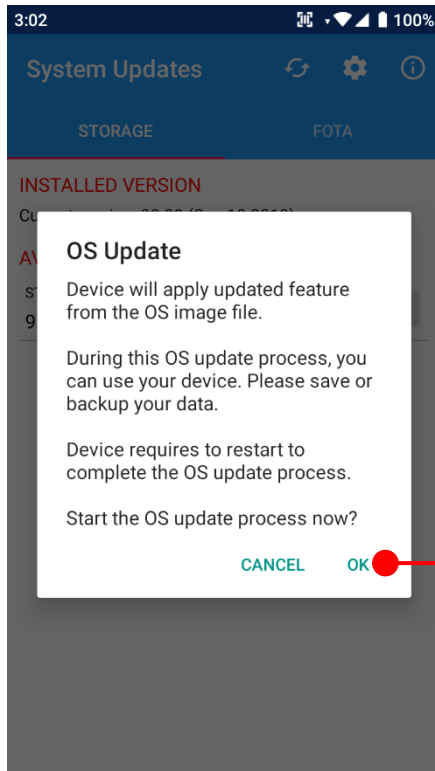

By touching the **OK** button, your PM90 start to update the OS image.  
Please save the data before restart to complete OS update process.

**Note:** Remaining battery level must be higher than 20%. Otherwise PM90 will not start OS update process.  
Please check battery level first

# OS Image update from the FOTA

## OS Update

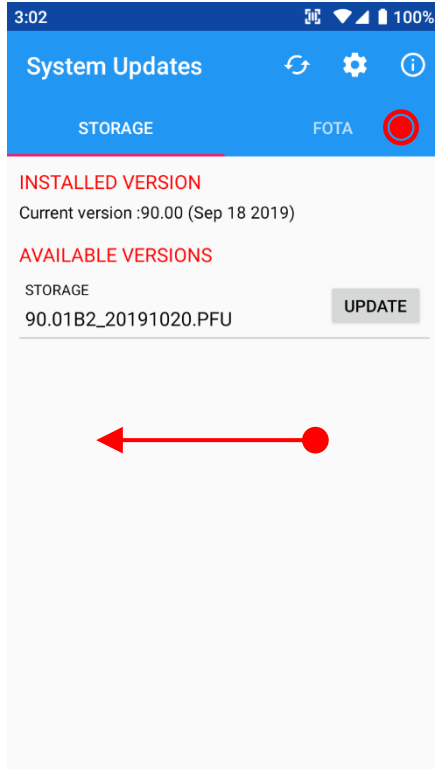

**Swipe** or touch **FOTA** tab

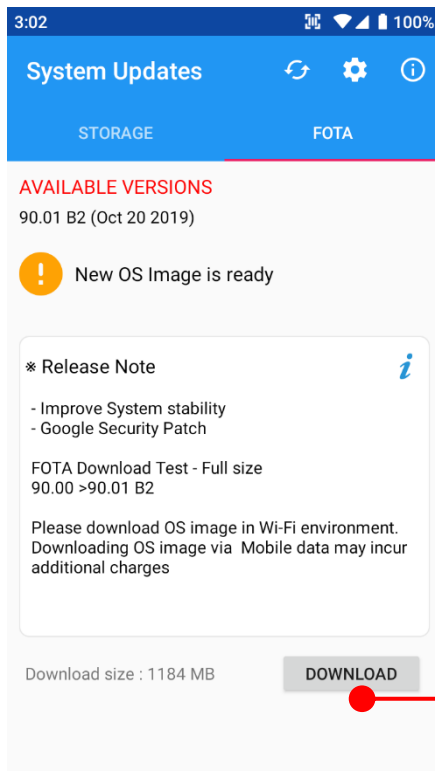

PM90 will compare the OS image between FOTA server and current OS image.  
If there is newer OS image in the FOTA server, App will suggest download latest OS image

Touch **DOWNLOAD**

# OS Image update from the FOTA

## OS Update

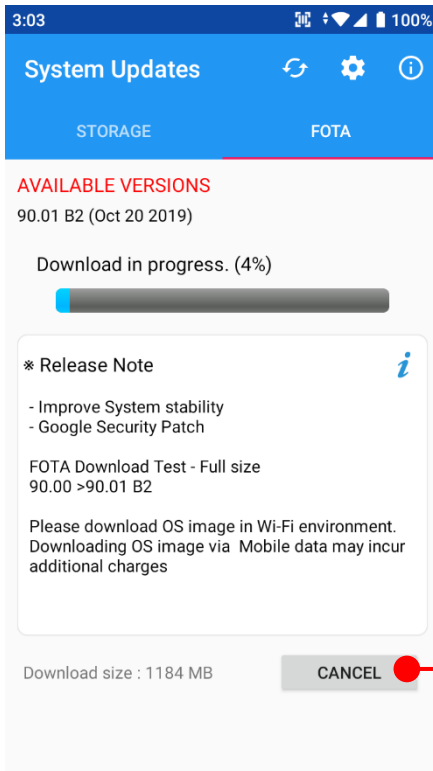

Touch to cancel the download process

By touching the **OK** button, your PM90 start to update the OS image.  
After OS update process, PM90 requires reboot

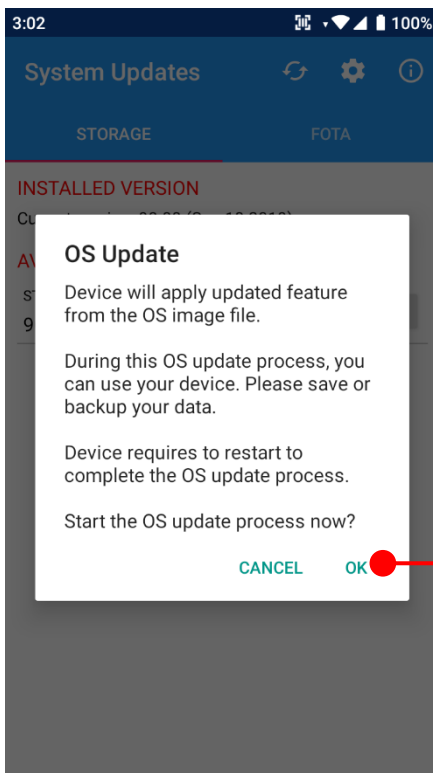

Please save the data before restart to complete OS update process.

**Note:** Default OS image download setting of FOTA Client is “Download over Wi-Fi only” Please connect to the nearby Wi-Fi network for FOTA service

Remaining battery level must be higher than 20%. Otherwise PM90 will not start OS update process. Please check battery level first

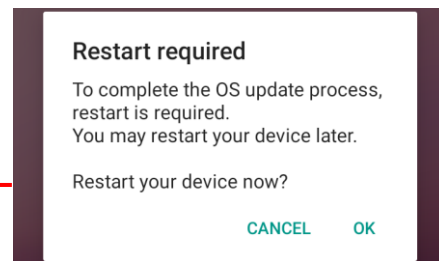

# Factory data reset from Settings

## Factory data reset

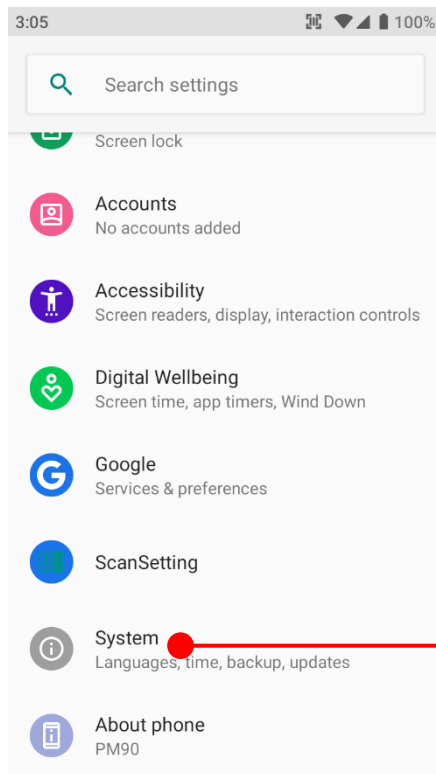

**Settings**  and then **System**

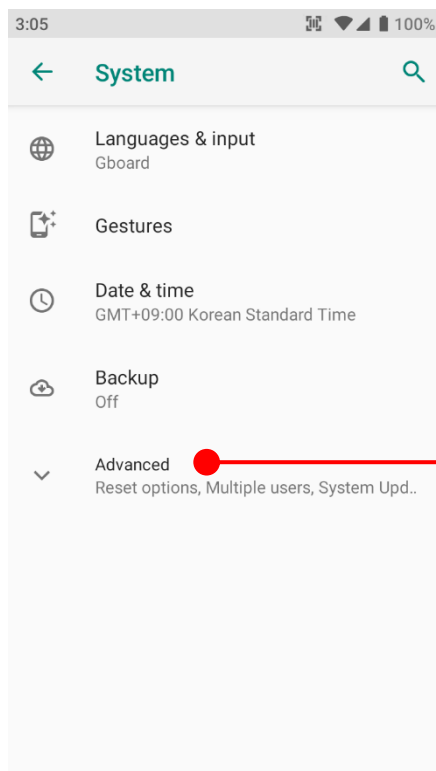

**Touch Advanced**

# Factory data reset from Settings

## Factory data reset

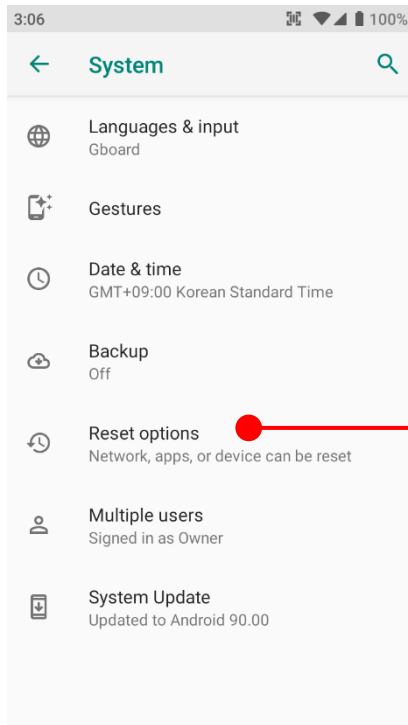

Touch **Reset options**

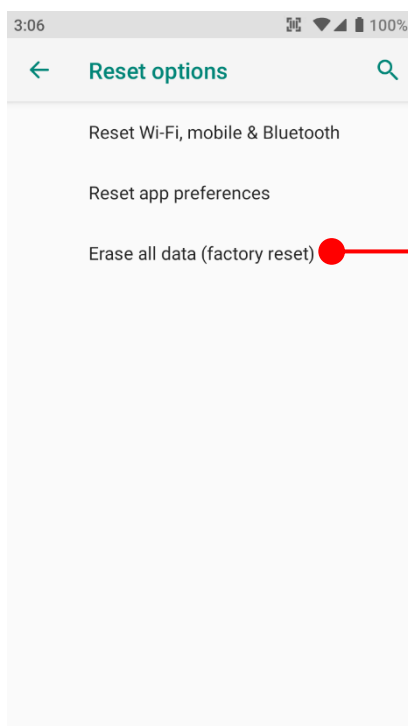

Touch **Erase all data (factory reset)**

# Factory data reset from Settings

## Factory data reset

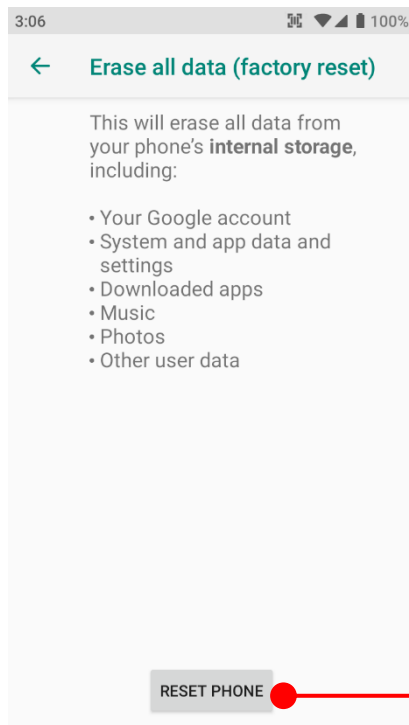

Please review reset item lists and touch **RESET PHONE**

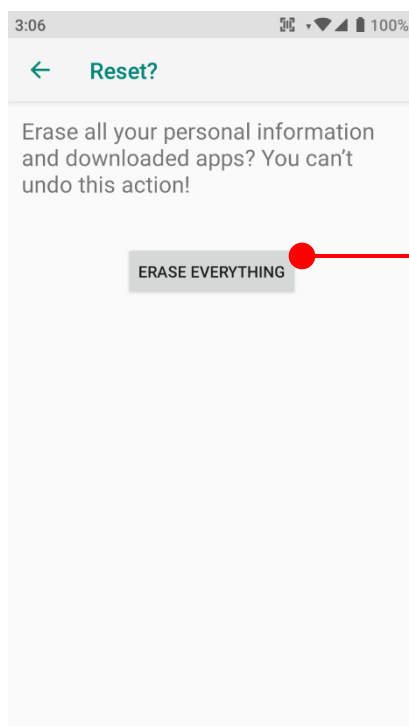

Please note, all apps and data in the internal storage will be deleted and restored to "Factory default" and this process cannot **Undo**

Touch **ERASE EVERYTHING**

## Force Factory data reset

## Factory data reset

### Force Factory data reset your PM90

You can perform “force” factory data reset your PM90. When your PM90 turned off, press **Power + Volume Up + Home** button all together. After you see **Smart Beyond Rugged** logo display, you may release the keys.

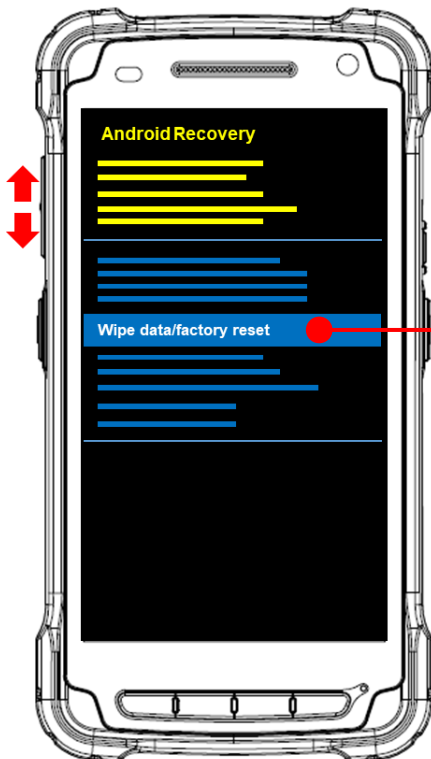

Select

PM90 enter to the **Android Recovery** mode. In this mode, **Volume up** is **Move Up** in the menu tree and **Volume down** is **Move Down** in the menu tree. **Power Button** is **Select**

Select **Wipe data/factory reset**

## Force Factory data reset

## Factory data reset



Select **Yes wipe all user data** to perform the Factory data reset.

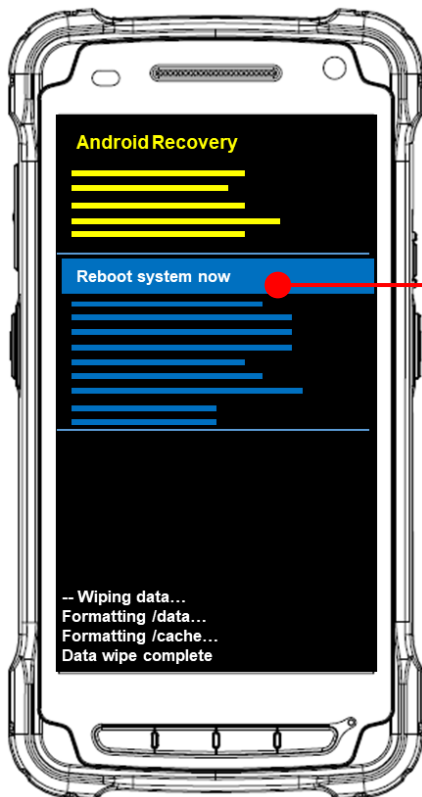

After data wiping, please select **Reboot system now** to finish the Force Factory data reset process



---

# Safety and Legal Info

## Battery Safety Information

Follow battery safety guidelines in this manual for safe usage and disposal of Li-ion batteries. Improper battery usage may result in an explosion, fire, or other critical hazards.

### Battery Usage & Disposal Guidelines

1. Use only Point Mobile approved batteries and charging accessories. Other batteries and charger may damage the device.
2. Do not disassemble or modify the battery. Do not bend, shred, deform the battery.
3. Do not expose the battery to excessive heat or cold. Do not place the battery into a microwave oven or dryer.
4. Do not short-circuit the battery or allow a foreign object to battery contacts.
5. Do not burn, expose to water, or other liquids the battery.
6. If battery leakage is observed, avoid any contact with the skin or eyes. If contact has been made, wash the affected area with water for 15 minutes, and seek medical attention.
7. Follow the local regulations for the disposal of used batteries.
8. Do not store or charge the battery in direct sunlight or in areas prone to get hot such as in a parked vehicle, near a heat duct, or close to other heat sources.

### Battery Charging Guidelines

1. Do not charge the battery in or near areas with materials that could obstruct charging or cause a short-circuit.
2. Do not charge the battery in the excessive hot or cold area.
3. Separate the charger from the battery as soon as possible when the battery is fully charged.

---

## Safety and Legal Info

### Battery Storage Guidelines

Storing the batteries is as important as using it safely. Battery is a core part of the device's performance so that you should treat the batteries safely.

1. Batteries should be stored in the clean, dry and ventilated environment within ambient temperature ranges of  $20\pm 5$  °C
2. Keep batteries away from corrosive substances.
3. Keep batteries away from fire and heat.
4. Batteries are charged while producing to below 20 ~ 30 % of full capacity for safety regulations.
5. Charge it for 30 minutes –1hour at least once every six months to prevent full discharge and keep the performance, when you are not using the battery for a long period.



**Notice:** *The battery is consumable goods. Point Mobile provides warranty for battery in 6 months after purchase.*

*If you suspect the battery swelling, change the battery and contact Point Mobile to use safely.*

## Safety and Legal Info

### Battery Warning

#### CAUTION

IF MISUSED OR MISTREATED THE BATTERY MAY PRESENT A RISK OF FIRE OR CHEMICAL BURN.  
RISK OF EXPLOSION IF BATTERY IS REPLACED BY AN INCORRECT TYPE.  
DISPOSE OF USED BATTERIES ACCORDING TO THE INSTRUCTIONS.

#### ATTENTION

Un remplacement inadéquat de la batterie ou une utilisation incompatible de l'appareil peut présenter des risques de brûlures, d'incendie, d'explosion ou d'autres dangers.

Jetez les piles en lithium-ion conformément aux réglementations locales.

### Body-worn Operation



This device was tested for typical bodyworn operations with the Front & back of the device kept 0.59 inches (1.5cm) between the

user's body and the Front & back of the device. To comply with FCC RF exposure requirements, a minimum separation distance of

0.59 inches (1.5cm) must be maintained between the user's body and the Front & back of the device. Any beltclips, holsters, and

similar accessories containing metallic components may not be used. Body-worn accessories that cannot maintain 0.59 inches (1.5cm)

[www.sar-tick.com](http://www.sar-tick.com)

separation distance between the user's body and the Front & back of the device, and have not been tested for typical body-worn

operations may not comply with FCC RF exposure limits and should be avoided.

---

## Safety and Legal Info

### FCC Warning

This device complies with part 15 of the FCC Rules. Operation is subject to the following two conditions: (1) This device may not cause harmful interference, and (2) this device must accept any interference received, including interference that may cause undesired operation.

This equipment has been tested and found to comply with the limits for a Class B digital device, pursuant to part 15 of the FCC Rules. These limits are designed to provide reasonable protection against harmful interference in a residential installation. This equipment generates, uses and can radiate radio frequency energy and, if not installed and used in accordance with the instructions, may cause harmful interference to radio communications. However, there is no guarantee that interference will not occur in a particular installation. If this equipment does cause harmful interference to radio or television reception, which can be determined by turning the equipment off and on, the user is encouraged to try to correct the interference by one or more of the following measures:

- Reorient or relocate the receiving antenna.
- Increase the separation between the equipment and receiver.
- Connect the equipment into an outlet on a circuit different from that to which the receiver is connected.
- Consult the dealer or an experienced radio/TV technician for help.

**Caution** : Any changes or modifications to this device not expressly approved by the party responsible for compliance could void your authority to operate the equipment.

### IC (Industry Canada) Warning

This device complies with Industry Canada license-exempt RSS standard(s). Operation is subject to the following two conditions: (1) This device may not cause interference; and (2) This device must accept any interference, including interference that may cause undesired operation of the device.

Le present appareil est conforme aux CNR d'Industrie Canada applicables aux appareils radio exempts de licence. L'exploitation est autorisee aux deux conditions suivantes : (1) l'appareil ne doit pas produire de brouillage, et (2) l'utilisateur de l'appareil doit accepter tout brouillage radioelectrique subi, meme si le brouillage est susceptible d'en compromettre le fonctionnement

This device is restricted to indoor use only within the 5.15 ~ 5.35GHz Band.

Cet appareil est restreint a l'utilisation a l'interieur seulement dans la bande 5.15 ~ 5.35GHz.

This equipment complies with FCC/IC radiation exposure limits set forth for an uncontrolled environment. This transmitter must not be collocated or operating in conjunction with any other antenna or transmitter unless authorized to do so by the FCC/IC.

Cet equipement est conforme aux limites d'exposition aux radiations FCC / IC definies pour un environnement non controle. Cet emetteur ne doit pas etre colocalise ou fonctionner en conjonction avec une autre antenne ou un autre emetteur, a moins d'etre autorise a le faire par le FCC / IC

---

## Safety and Legal Info

### Laser Warning

- LASER LIGHT. DO NOT STARE INTO BEAM. CLASS 2 LASER PRODUCT. 1.0 mW MAX OUTPUT 650 nm.

(LUMIERE LASER, NE PAS REGARDER DIRECTEMENT DANS LE FAISCEAU, PRODUIT LASER DE CLASSE 2, SORTIE MAX. DE 1,0 MW: 650 nm.)

- Complies With 21CFR 1040.10 and 1040.11 except for deviations pursuant to Laser Notice No.50 dated June 24 2007. (Cet appareil a ete teste et reconnu conforme aux normes 21 CFR 1040.10 et 1040.11sauf pour les derogations en accord avec l'avis de conformite sur les lasers No. 50, en date du 24 juin 2007.)

### E-label

Users can access to the product certificate information in Settings → About phone → Certificates.

WCDMA/LTE feature is optional. Some product options only include WLAN feature.

FCC ID : V2X-PM90G (PHONE), V2X-PM90W (WLAN)

IC ID : 10664A-PM90G (PHONE), 10664A-PM90W (WLAN)

## Safety and Legal Info

### KC 사용 안전정보

본 제품의 전자파흡수율은 과학기술정보통신부의 「전자파 인체보호기준」을 만족합니다.

본 제품은 국립전파연구원의 「전자파흡수율 측정기준」에 따라 최대 출력 조건에서 귀에 근접하여 시험되었으며, 최대 전자파 흡수율 측정값은 다음과 같습니다.

Model 명	PM90
머리 전자파흡수율	0.971 W/kg

※ 전자파흡수율 (SAR : Specific Absorption Rate)은 휴대전화를 사용할 때 인체에 흡수될 수 있는 전자파의 양으로 우리나라는 국제권고기준인 2 W/kg 보다 엄격한 1.6 W/kg 기준을 적용하고 있습니다.

※ 전자파흡수율에 대한 자세한 정보는 국립전파연구원 ([www.rra.go.kr](http://www.rra.go.kr)) 또는 제조사 홈페이지에서 확인할 수 있습니다.

※ 본 기기는 인체로부터 15 mm 이상 이격 하여 사용하는 것을 권장합니다

적합성 평가	내용
기자재의 명칭	LTE 이동통신용 무선설비의 기기(육상이동국의 송수신장치)
모델명	PM90
상호명	주식회사 포인트모바일
제조사/제조국가	주식회사 포인트모바일 / 중국
제조년월	2019



## **Point Mobile. Co., Ltd.**

### **Offline**

Tel: +82-2-3397-7870~1

ARS: +82-1800-3010

Fax: +82-2-3397-7872

Address: 9F Kabul Great Valley, 32, Digital-ro 9-gil,  
Geumcheon-gu, Seoul, Korea 08512

### **Online**

Website: <https://www.pointmobile.com>

E-mail: [pm\\_support@pointmobile.com](mailto:pm_support@pointmobile.com)